



Thank you for your purchase of Premio OSS212L-D5 Storage Server System!

1. Check the Content of the box. Please confirm that your package contains the following:

#	Description	Image / Description	Qty
1	OSS212L-D5 Enclosure		1
2	Motherboard	Tyan S7100GM2NR	1
3	CPU and memory	Intel Skylake and DDR4	Opt.
4	IO Cards		Opt.
5	Heatsink		2
6	2x 2.5" Drive Bay		Opt.
7	Slide Rail Kit + Screws		1 set
8	Power Cable*		2
9	Serial Cable*		1

* Inside the accessories box. Box may consist of screw sets for rail kit or drives. If any items are missing, please contact your reseller or sales rep.

2. Get Familiar with the Unit.

OSS212L-D5 is a storage server supporting dual Intel processor and front tray-less 12x 3.5" HDDs, an optional rear 2x 2.5" OS drive and 7x low profile PCIe slots in a 2U space. Tyan S7100GM2NR and internal cabling are preinstalled. Other motherboard model, IO cards, CPU, and memory can be preinstalled upon request.

Front view of the unit

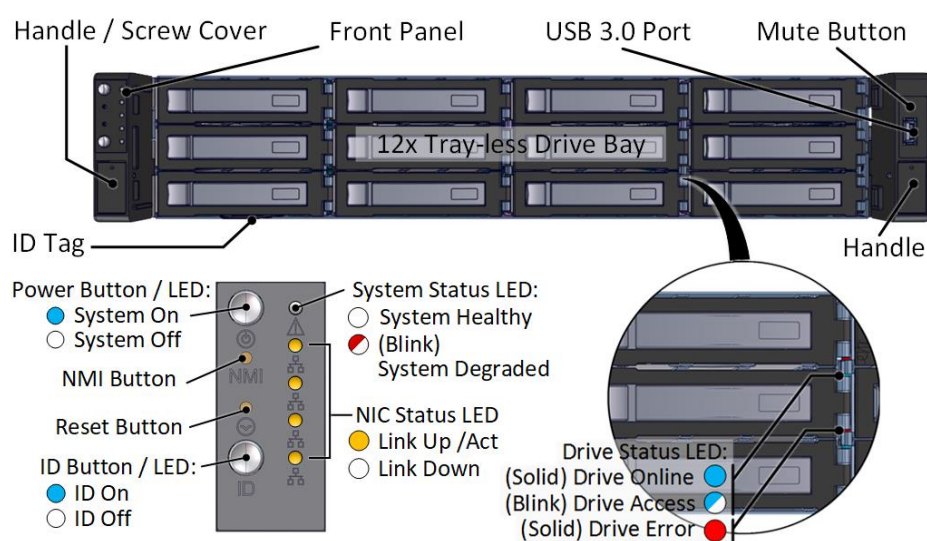

Rear view of the unit

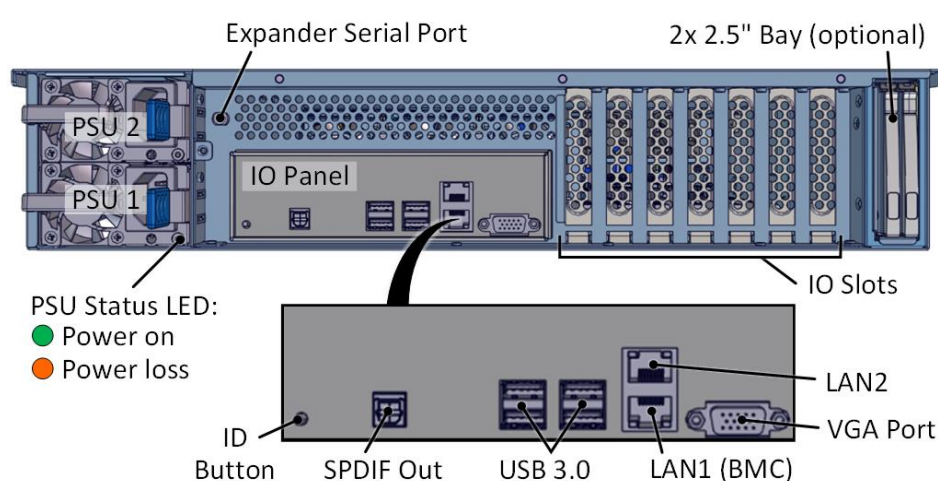

3. Remove the Top Covers of the unit as follows:

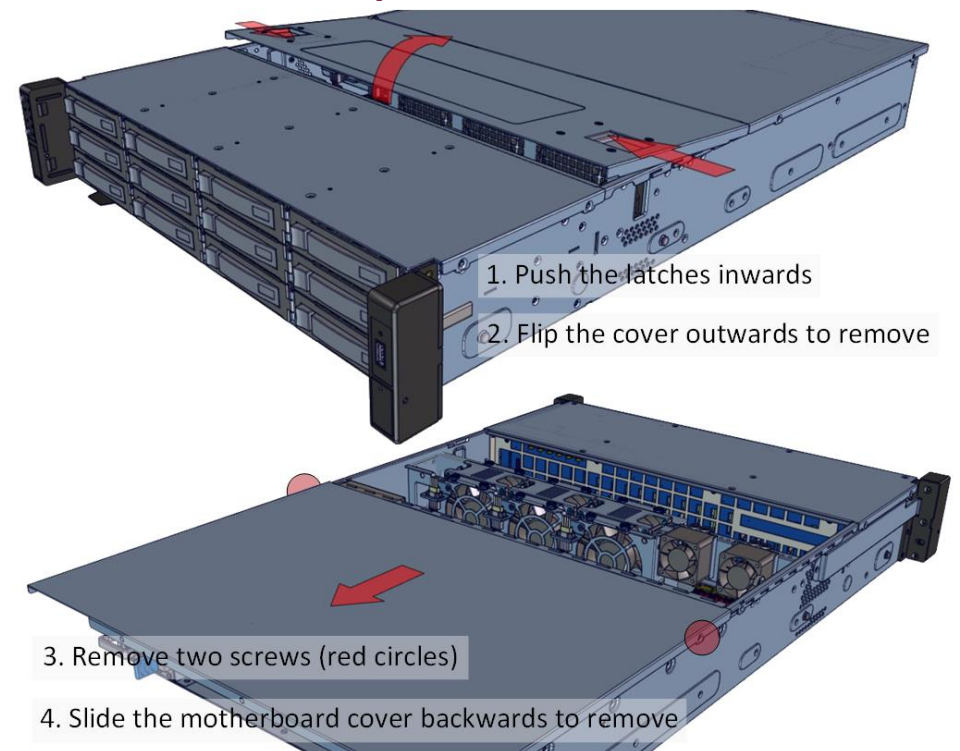

Remove the middle cover to get access to internal fans. The rear cover is for motherboard access.

4. Inspect the Inside of the unit. Internal components comprise of a Tyan motherboard, an expander board (to IO cards), an optional rear 2x 2.5" bay, 3x system fan modules and 2x IO card fan modules (all connected to the motherboard).

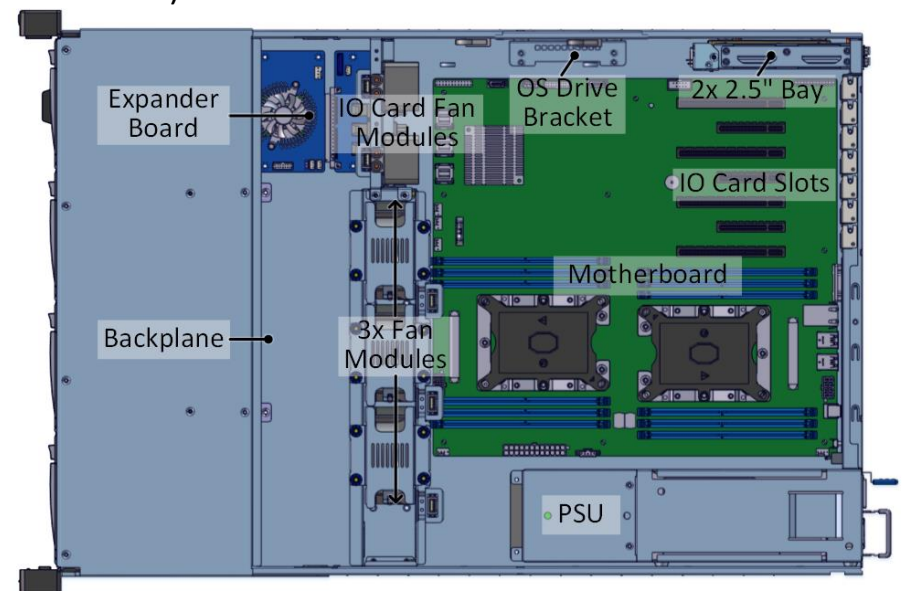

See two options below to install OS disks.



Installation and service of this product should be conducted by a trained personnel to avoid bodily injury from electric shock or heavy object



Observe ESD (Electrostatic Discharge) practices during integration to avoid possible damage to the board and / or other components

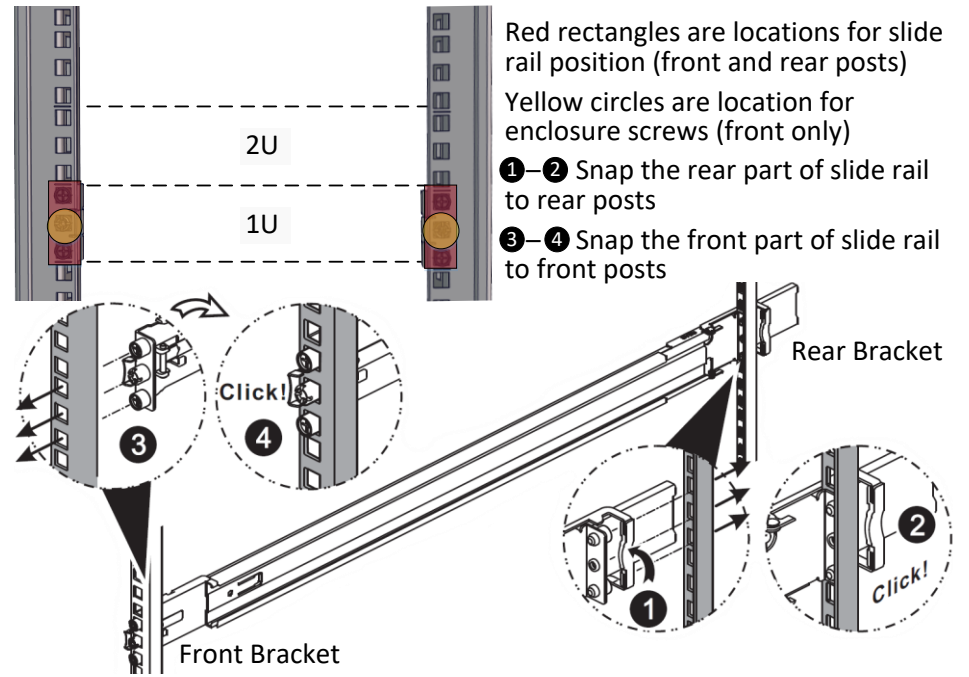
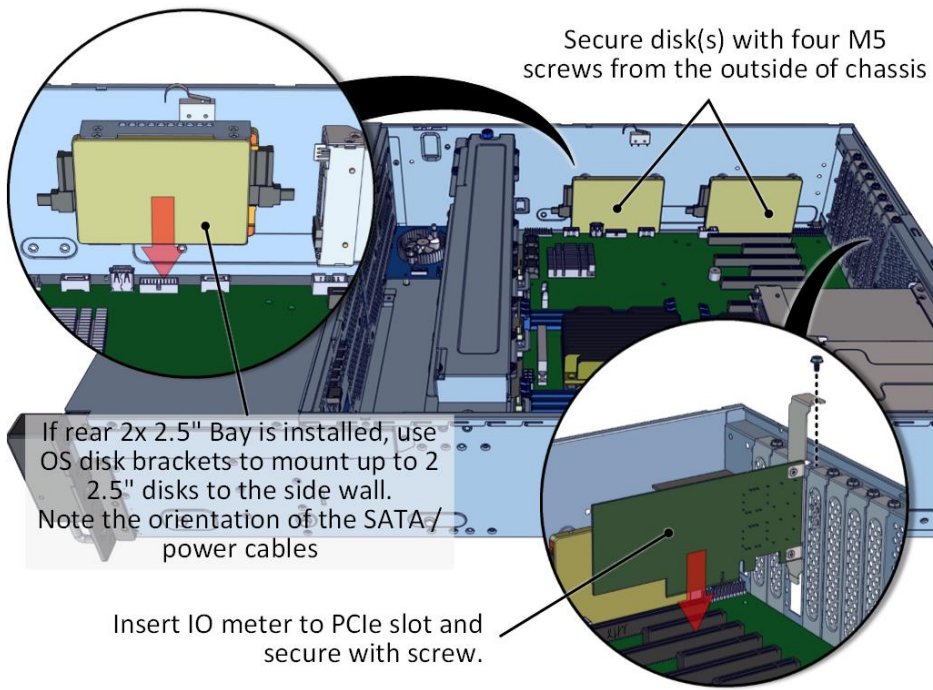

5. Install Motherboard Components (CPU, heatsink, memory) using the guidelines below. For further details, refer to the motherboard TPS.

- Support Intel Xeon Skylake Processor Family
- 2x LGA3647 Sockets
- Max up to 205W TDP
- Intel C621 PCH Chipset
- 6+6 DDR4 RDIMM/LRDIMM 2666
- Up to 384GB RDIMM / 768GB LRDIMM / 1536GB RDIMM 3DS
- 6 Channels per CPU, 1.2V
- Populate from A0 → F0
- PCIe1, PCE3 (Gen3x16), PCIe2 (Gen3x8) f/ CPU0
- PCIe5, PCE7 (Gen3x16), PCIe4, PCIe6 (Gen3x8) f/ CPU1

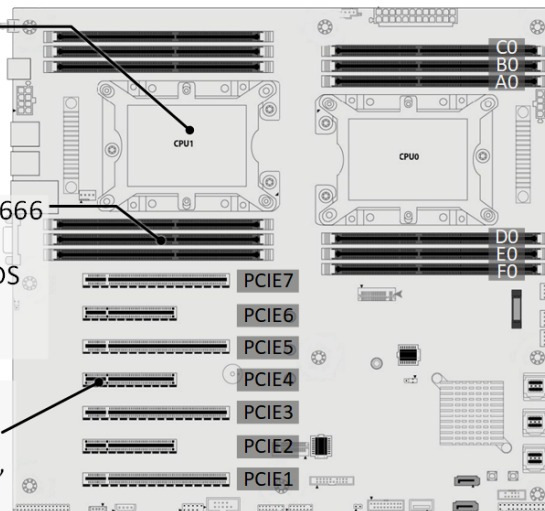

To remove slide rails, use the latches to undo the assembly as follows:

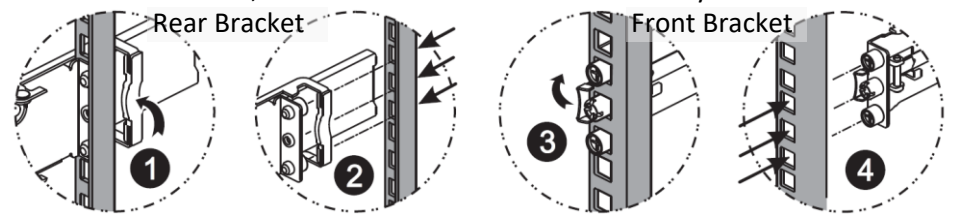

9. Install the Unit to the Rack as follows:

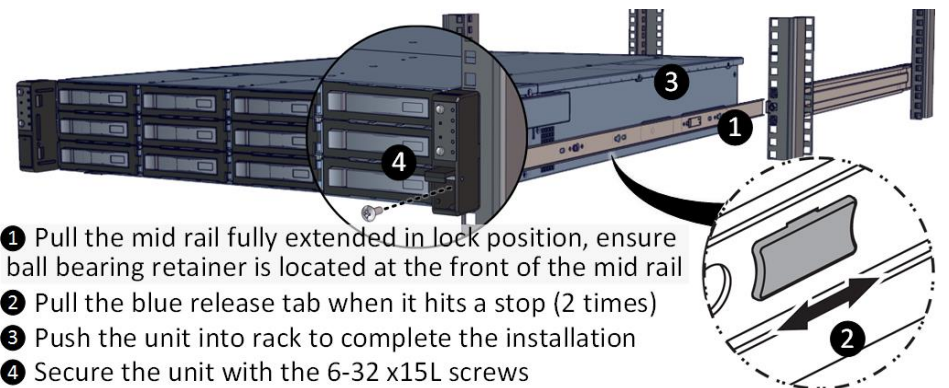

For a complete instruction on how to install unit to the rack, please follow the Slide Rail Installation Guide.



At least two people are recommended for mounting process.

6. Remove the Inner Rail from the slide rail.

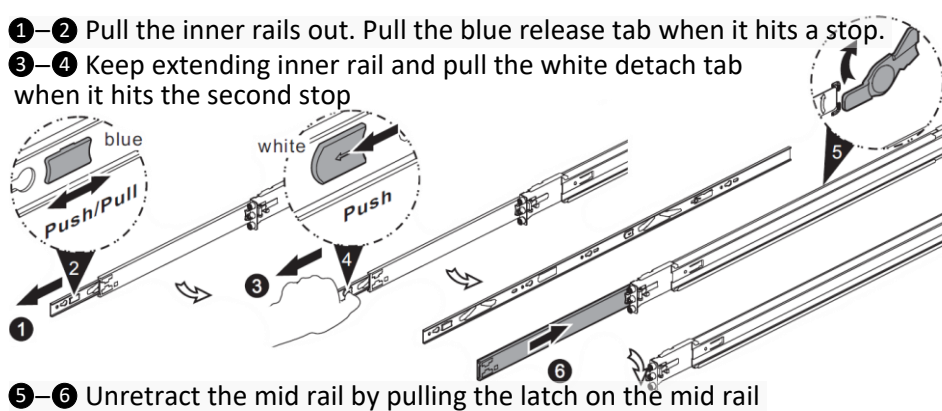

7. Install Inner Rails to the enclosure.

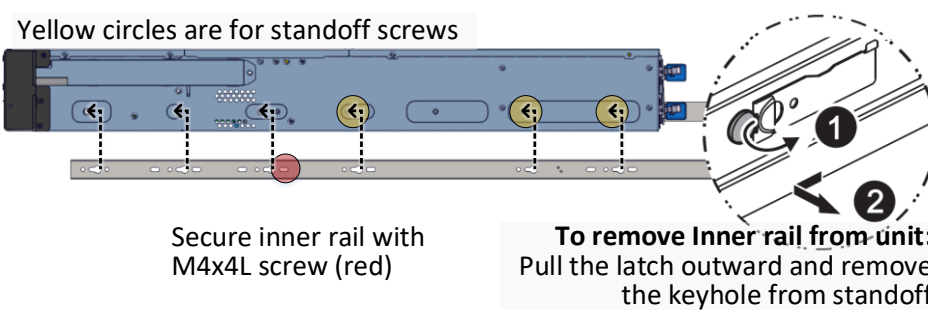

10. Install 2.5" Drives to the enclosure as illustrated:

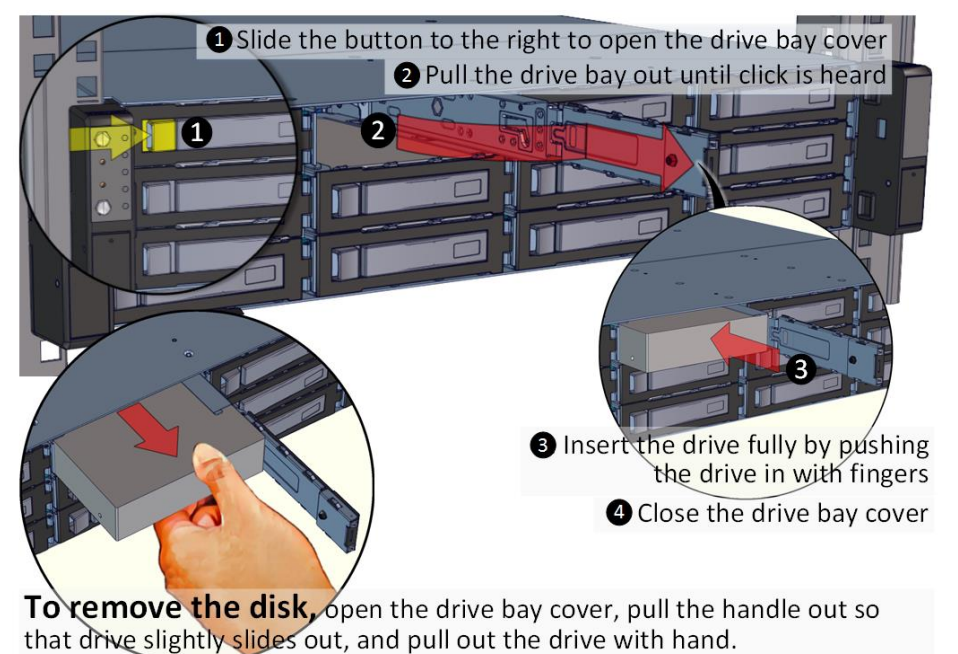

8. Install the Outer Rails to the Rack as follows:

11. Drive Mapping of OSS212L-D5 is as follows:



12. Plug in the Power Cords to the AC receptacles on the back of the unit.



13. Press the Power Button on the front of the unit and for the system to boot up.

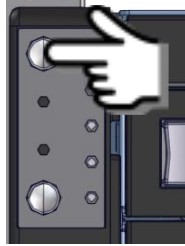

14. Access the Serial Console (when necessary) by connecting a serial audio cable to the one of the console ports. Use a terminal console with baud set 38400, 8, N, 1, N. Type “help -a” for a list of commands.

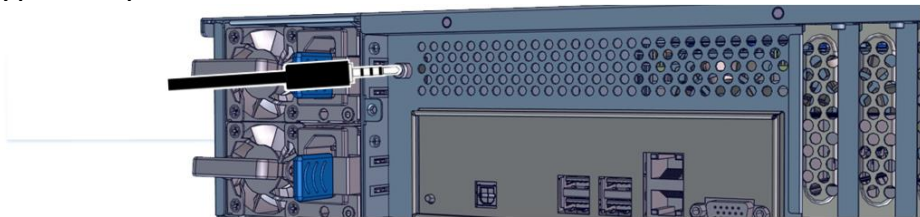

For management through Eth port, refer to unit’s User’s Guide.