

USER'S MANUAL

JCO-1000-ORN-C

Entry-Level AI Edge Computer with
NVIDIA Jetson Orin™ NX Super/Nano Super



Table of Contents

Prefaces	04
Revision	04
Disclaimer	04
Copyright Notice	04
Trademarks Acknowledgment	04
Environmental Protection Announcement	04
Safety Precautions	05
Technical Support and Assistance	06
Conventions Used in this Manual	06
Package Contents	07
Ordering Information	07
Optional Accessory	08
Chapter 1 Product Introductions	09
1.1 Overview	10
Key Feature	10
1.2 Hardware Specification	11
1.3 System I/O	14
1.4 Mechanical Dimension	16
Chapter 2 Mechanical Specifications.....	17
2.1 Switch and connector Locations	18
2.1.1 Top View	18
2.1.2 Bottom View	19
2.2 Connector / Switch Definition	20
2.3 I/O Interface Descriptions	21
Chapter 3 System Setup	38
3.1 Set torque force to 3.5 kgf-cm to screw or unscrew system parts	39
3.2 Removing the upper cover	39
3.3 Install M.2 M Key Socket	40
3.4 Install M.2 B Key Communication Module and Antenna	42
3.5 Install M.2 E Key Wi-Fi and Antenna	45
3.6 Installing Wall Mount	48
Chapter 4 Software Setup Guide	49
4.1 OS Flash Image Guide	50
4.1.1 Preparation	50
4.1.2 Flash BSP Image	51
4.2 MCU Control Functions	53
4.2.1 Control Functions	53
4.2.2 LED Control	53
4.2.3 GPIO Control	54
4.2.4 Device Mode Status	56
4.2.5 Buzzer Control	57
4.2.6 Power on Buzzer Control	57
4.2.7 IGN Power On/Off Delay Time Control	58

Table of Contents

4.2.8 Setting Save Control	60
4.2.9 GPIO Configuration Control	61
4.3 Create USERNAME and PASSWORD	63
4.4 GMSL Camera	64

Prefaces

Revision

Revision	Description	Date
1.0	Manual Released	2026/3/12

Disclaimer

All specifications and information in this User's Manual are believed to be accurate and up to date. Premio Inc. does not guarantee that the contents herein are complete, true, accurate or non-misleading. The information in this document is subject to change without notice and does not represent a commitment on the part of Premio Inc.

Premio Inc. disclaims all warranties, express or implied, including, without limitation, those of merchantability, fitness for a particular purpose with respect to contents of this User's Manual. Users must take full responsibility for the application of the product.

Copyright Notice

All rights reserved. No part of this manual may be reproduced or transmitted in any form or by any means, electronic or mechanical, including photocopying, recording, or information storage and retrieval systems, without the prior written permission of Premio Inc. Copyright © Premio Inc.

Trademarks Acknowledgment

Intel®, Celeron® and Pentium® are trademarks of Intel Corporation.

Windows® is registered trademark of Microsoft Corporation.

AMI is trademark of American Megatrend Inc.

IBM, XT, AT, PS/2 and Personal System/2 are trademarks of International Business Machines Corporation

All other products and trademarks mentioned in this manual are trademarks of their respective owners.

Environmental Protection Announcement

Do not dispose this electronic device into the trash while discarding. Please recycle to minimize pollution and ensure environment protection.

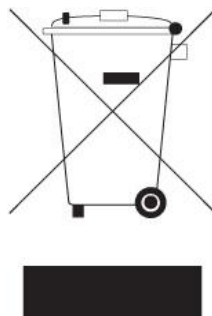

Safety Precautions

Before installing and using the equipment, please read the following precautions:

- Put this equipment on a reliable surface during installation. Dropping it or letting it fall could cause damage.
- The power outlet shall be installed near the equipment and shall be easily accessible.
- Turn off the system power and disconnect the power cord from its source before making any installation. Be sure both the system and the external devices are turned OFF. Sudden surge of power could ruin sensitive components. Make sure the equipment is properly grounded.
- When the power is connected, never open the equipment. The equipment should be opened only by qualified service personnel.
- Make sure the voltage of the power source is correct before connecting the equipment to the power outlet.
- Disconnect this equipment from the power before cleaning. Use a damp cloth. Do not use liquid or spray detergents for cleaning.
- Avoid the dusty, humidity and temperature extremes.
- Do not place heavy objects on the equipment.
- If the equipment is not used for long time, disconnect it from the power to avoid being damaged by transient over-voltage.
- The storage temperature shall be above -30°C and below 85°C .
- The computer is provided with a battery-powered real-time clock circuit. There is a danger of explosion if incorrectly replaced. Replace only with the same or equivalent type recommended by the manufacturer.
- If one of the following situation arises, get the equipment checked by service personnel:
 - The power cord or plug is damaged.
 - Liquid has penetrated into the equipment.
 - The equipment has been exposed to moisture.
 - The equipment does not work well or it cannot work according the user's manual.
 - The equipment has been dropped and damaged.
 - The equipment has obvious signs of breakage.

Technical Support and Assistance

1. Visit the Premio Inc website at www.premioinc.com where you can find the latest information about the product.
2. Contact your distributor, our technical support team or sales representative for technical support if you need additional assistance. Please have following information ready before you call:
 - Model name and serial number
 - Description of your peripheral attachments
 - Description of your software (operating system, version, application software, etc.)
 - A complete description of the problem
 - The exact wording of any error messages

Conventions Used in this Manual

**WARNING**

This indication alerts operators to an operation that, if not strictly observed, may result in severe injury.

**CAUTION**

This indication alerts operators to an operation that, if not strictly observed, may result in safety hazards to personnel or damage to equipment.

**NOTE**

This indication provides additional information to complete a task easily.

Package Contents

Before installation, please ensure all the items listed in the following table are included in the package.

Item	Description	Q'ty
1	JCO-1000-ORN-C Entry Level AI Edge Computer	1
2	Wall Mount Kit	1
3	Accessory Kit	1

Ordering Information

Model No.	Product Description
JCO-1000-ORN-C	Entry Level AI Edge Computer with NVIDIA Jetson Orin™ NX Super/Nano Super, 2x LAN
JCO-1000-ORN-C-NX8	Compact Fanless Edge AI Embedded Computer with NVIDIA® Jetson Orin™ NX Super 8G, 1x HDMI, 2x LAN, 2x USB, 1x CAN
JCO-1000-ORN-C-NN8	Compact Fanless Edge AI Embedded Computer with NVIDIA® Jetson Orin™ Nano Super 8G, 1x HDMI, 2x LAN, 2x USB, 1x CAN
JCO-1000-ORN-C-NN4	Compact Fanless Edge AI Embedded Computer with NVIDIA® Jetson Orin™ Nano Super 4G, 1x HDMI, 2x LAN, 2x USB, 1x CAN
JCO-1000-ORN-C-NX16-4GML	Compact Fanless Edge AI Embedded Computer with NVIDIA® Jetson Orin™ NX Super 16G, 1x HDMI, 2x LAN, 2x USB, 1x CAN, 4x GMSL
JCO-1000-ORN-C-NX8-4GML	Compact Fanless Edge AI Embedded Computer with NVIDIA® Jetson Orin™ NX Super 8G, 1x HDMI, 2x LAN, 2x USB, 1x CAN, 4x GMSL
JCO-1000-ORN-C-NN8-4GML	Compact Fanless Edge AI Embedded Computer with NVIDIA® Jetson Orin™ Nano Super 8G, 1x HDMI, 2x LAN, 2x USB, 1x CAN, 4x GMSL
JCO-1000-ORN-C-NN4-4GML	Compact Fanless Edge AI Embedded Computer with NVIDIA® Jetson Orin™ Nano Super 4G, 1x HDMI, 2x LAN, 2x USB, 1x CAN, 4x GMSL

Optional Accessories

Model No.	Product Description
1-E09A15002	Adapter AC/DC 24V 6.3A 150W with 3-pin Terminal Block Plug 5.0mm Pitch
1-TPCD00008	Power Cord, 3-pin US Type, 180cm
1-TPCD00011	Power Cord, 3-pin UK Type, 180cm
1-TPCD00009	Power Cord, 3-pin European Type, 180cm
1-TPCD00013	Power Cord, 3-pin Austria Type, 180cm
1-TPCD00014	Power Cord, 3-pin Japanese Type, 180cm
1-TFAK00003	Fakra-Z Extension Cable, 100cm
1-TFAK00002	Fakra-Z Extension Cable, 300cm
1-TFAK00004	Fakra-Z Extension Cable, 500cm
1-TFAK00005	Fakra-Z Extension Cable, 1000cm
1-TFAK00006	Fakra-Z Extension Cable, 1500cm

Chapter 1

Product Introductions

1.1 Overview

Featuring NVIDIA Jetson Orin NX (16GB/8GB) and Nano (8GB/4GB) Orin system-on-module (SOM), the JCO-1000 Series offers entry-level AI performance with up to 157 TOPS in the whole JCO series. With configurable power modes (10W to 40W), rugged design, NVMe data storage, and rich I/O, the JCO-1000-ORN is deployment-ready for the harshest conditions.

Model No.	Rear Panel	Front Panel
JCO-1000-ORN-C		

Key Features

- NVIDIA® Jetson Orin™ NX Super 8GB/16GB or Nano Super 8GB/4GB GPU with 32 Tensor Cores
- 1x HDMI 2.0, Up to 3840 x 2160 @ 60Hz
- 2x M12 LAN (1x GbE, 1x 2.5 GbE)
- 1x External Dual Nano SIM socket
- 1x M.2 (M Key, 2242/2280, PCIe x4, NVMe Storage) (128GB Default)
- 1x USB 3.2 Gen 2, 1x USB 2.0
- 4x DI + 4x DO with isolation
- Support 4x GMSL Camera
- 9 to 36VDC Wide Range Power Input Supporting AT/ATX Mode
- Wide Operating Temperature -20°C up to 55°C

1.2 Hardware Specification

System

Processor

NVIDIA® Jetson Orin™ NX Super/Nano Super GPU with 32 Tensor Cores

- NX 16 GB: 1024-core NVIDIA Ampere architecture GPU (40W/157 TOPS)
- NX 8 GB: 1024-core NVIDIA Ampere architecture GPU (40W/117 TOPS)
- Nano 8 GB: 1024-core NVIDIA Ampere architecture GPU (25W/67 TOPS)
- Nano 4 GB: 512-core NVIDIA Ampere architecture GPU (25W/34 TOPS)

LAN Chipset

RJ45 GbE: RGMII
2.5 RJ45 GbE2: INTEL LAN Chip

Audio Codec

ALC5640

Watchdog

Software Programmable Supports 1~110 sec. System Reset

TPM

TPM 2.0

Display

HDMI

- NX Series
1x HDMI 2.0, 3840 x 2160 @ 60Hz
- Nano Series
1x HDMI 1.4, 3840 x 2160 @ 30Hz

Storage

M.2

1x M.2 (M Key, 2242/2280, PCIe x4, NVMe) (Default 128GB)

SD

1x Micro SD 2.0 Slot

SIM Socket

1x External Dual Nano SIM socket (Attached to M.2 B Key)

Expansion

M.2

- 1x M.2 (B Key, 2242/3042/3052, PCIe x1, USB 3.2 Gen2, Support 4G/5G Module)
- 1x M.2 (E Key, 2230, PCIe x1, USB 2.0, Support Wi-Fi/Bluetooth)

I/O	
CAN	CAN 2.0 B
COM	1x RS-232/422/485 (Switchable by Software) 1x RS-232/422/485 (Internal)
DIO	4 in / 4 out (Isolated)
GMSL Camera	Support 4x GMSL 2 Camera Support by 1x Quad Port Mini Fakra (Optional)
LAN	2x M12 LAN
USB	1x USB 3.2 Gen 2 (10 Gbps), 1x USB 2.0 1x USB Type-C (For OS Flash) 1x Micro USB (For Console)
LED	3x LED LED 1 : Programmable LED (Blue Color) LED 2 : Programmable LED (Blue Color) LED 3 : Programmable LED (Red Color)
Others	Service Panel: <ul style="list-style-type: none"> • 1x Micro USB (For Console) • 1x USB Type-C (For OS Flash) • 1x PC/CAR Mode Switch • 1x AT/ATX SW • 1x Micro SD Slot • 1x Dual SIM Slot 5x Wi-Fi Antenna Holes 1x Power Switch and 1x Reset Switch 1x 2P Terminal Block for Remote SW 1x CMOS Battery Cable 1x 1x7-Pin Connector for MIC-IN & Line Out integrated RTC integrated G sensor & Gyroscope 1x M4 Grounding Screw

Operating System

Linux	Linux Ubuntu 22.04 with JetPack 6.2
-------	-------------------------------------

Power

Power Adapter	Optional AC/DC, 24V/6.3A 150W
Power Mode	AT, ATX
Power Supply Voltage	DC IN 9~36V
Power Connector	3-pin Terminal Block
Power Protection	OVP (Over Voltage Protection) OCP (Over Current Protection) Reverse Protection

Environment

Operating Temp.	-20°C to 55°C (15W, 25W) -20°C to 35°C (40W)
Storage Temp.	-30°C to 85°C
Relative Humidity	10% to 95% (non-condensing)
Certification	UL 62368-1 3rd Ed. CE, FCC Class B E-mark (24) EMC Conformity with EN50121-3-2 RoHS 3.0, REACH
Vibration	With SSD: 5 Grms (5 - 500 Hz, 0.5 hr/axis)
Shock	With SSD: 50G half-sin 11ms

Physical

Dimensions	150 (W) x 105 (D) x 65 (H) mm
Weights	1.1kg
Construction	Extruded Aluminum with Heavy Duty Metal
Mounting Options	Wall Mounting

* All specifications and photos are subject to change without notice.

1.3 System I/O

JCO-1000-ORN-C

Front Panel

DC IN

Used to plug a DC power input with terminal block

USB 3.2 Gen 2 / USB 2.0 port

Used to connect USB device

HDMI

Used to connect HDMI-compatible devices

M12 LAN ports

Used to connect the system to a local area network

Remote Power on/off

Used to plug a remote power on/off terminal block

Reset Switch

Used to Power Reset

Power Switch

Used to Power start button

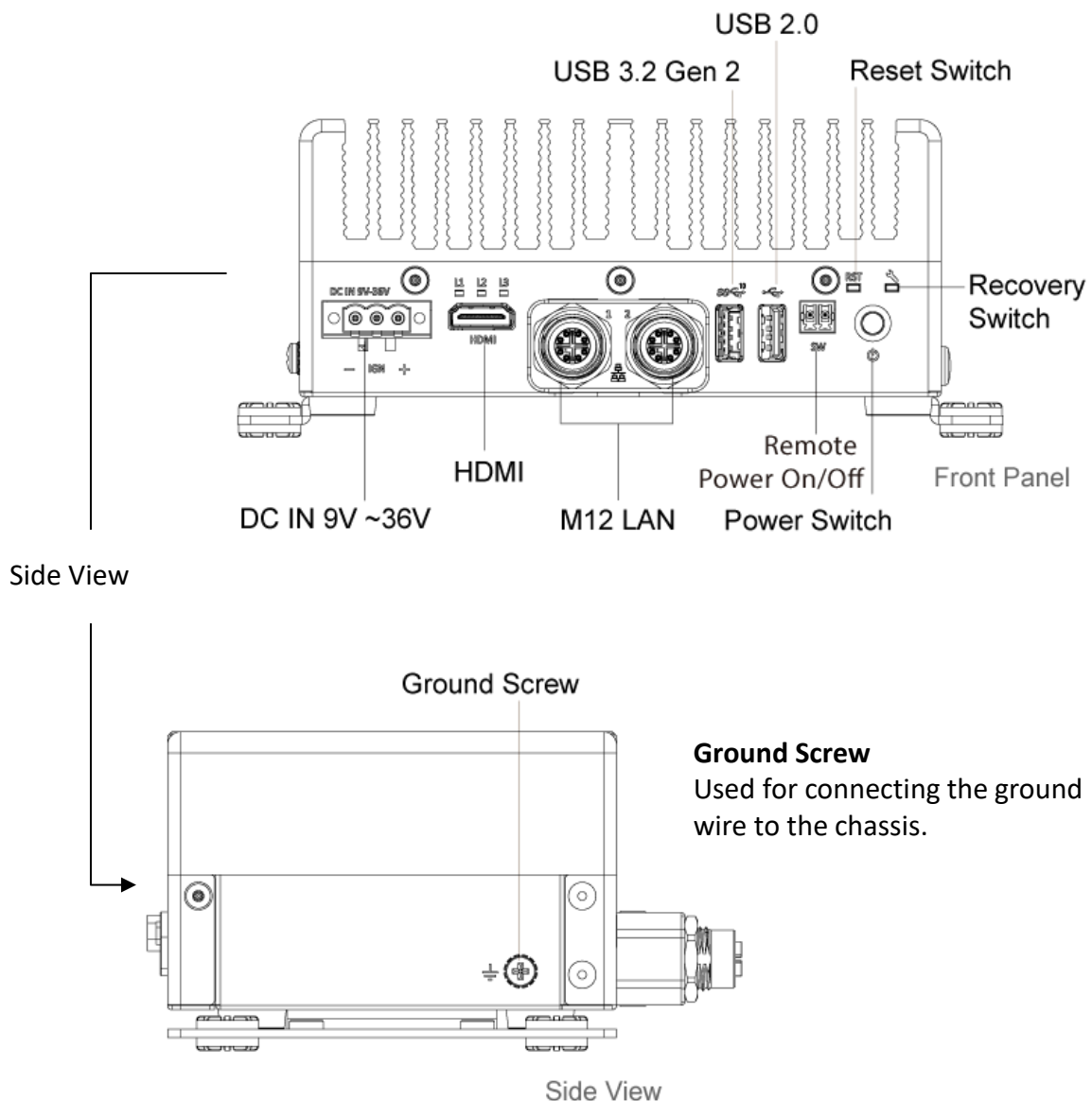

Ground Screw
Used for connecting the ground wire to the chassis.

JCO-1000-ORN-C

Rear Panel

Digital I/O

The Digital I/O terminal block supports 4 digital input and 4 digital output

COM port

COM1 support RS232/422/485 serial device

CAN

Used to connect an ECU (Electronic control unit) device with D-SUB 9 pin connector

GMSL:

4x GMSL 2 Camera Support by 1x Quad Port Mini Fakra (Optional)

Used to connect GMSL Camera

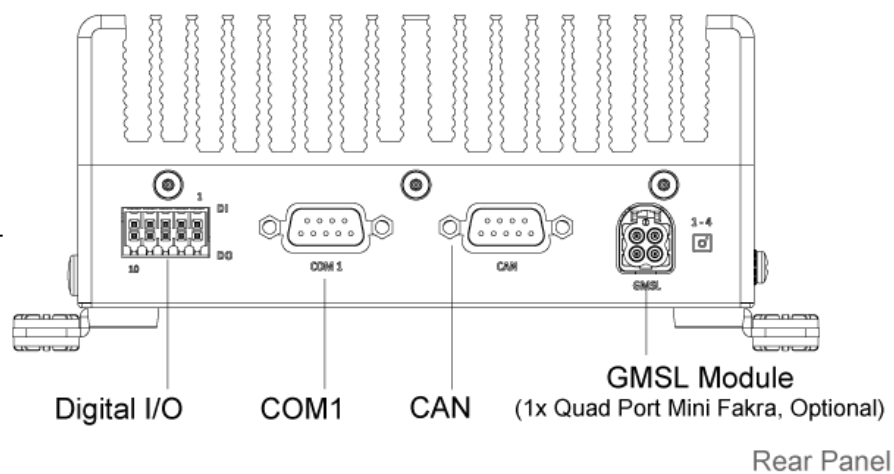

Side View

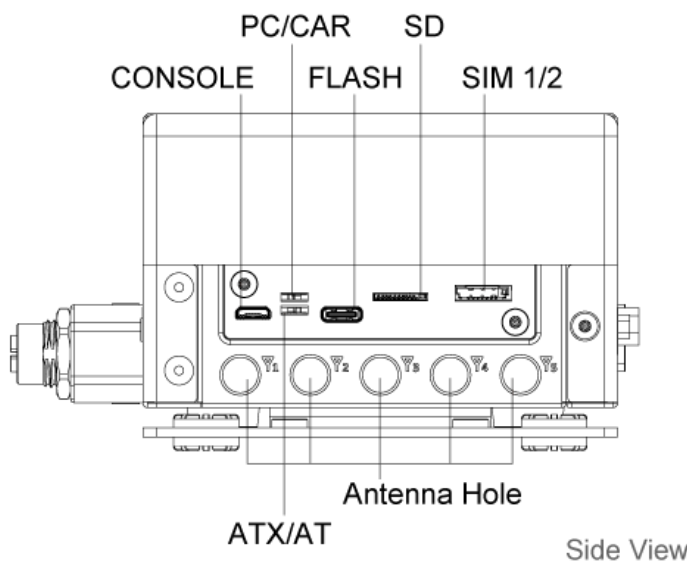

SIM 1/2

The SIM card has 2 slots located on the Side View of the system, SIM 1 and SIM 2.

SD

Used to insert SD card

PC/Car mode select switch

Used to select PC or Car mode

AT/ATX mode select switch

Used to select AT or ATX power mode

Antenna hole

Used to connect an antenna for optional M.2 Wi-Fi module

1.4 Mechanical Dimensions

JCO-1000-ORN-C

Unit: mm

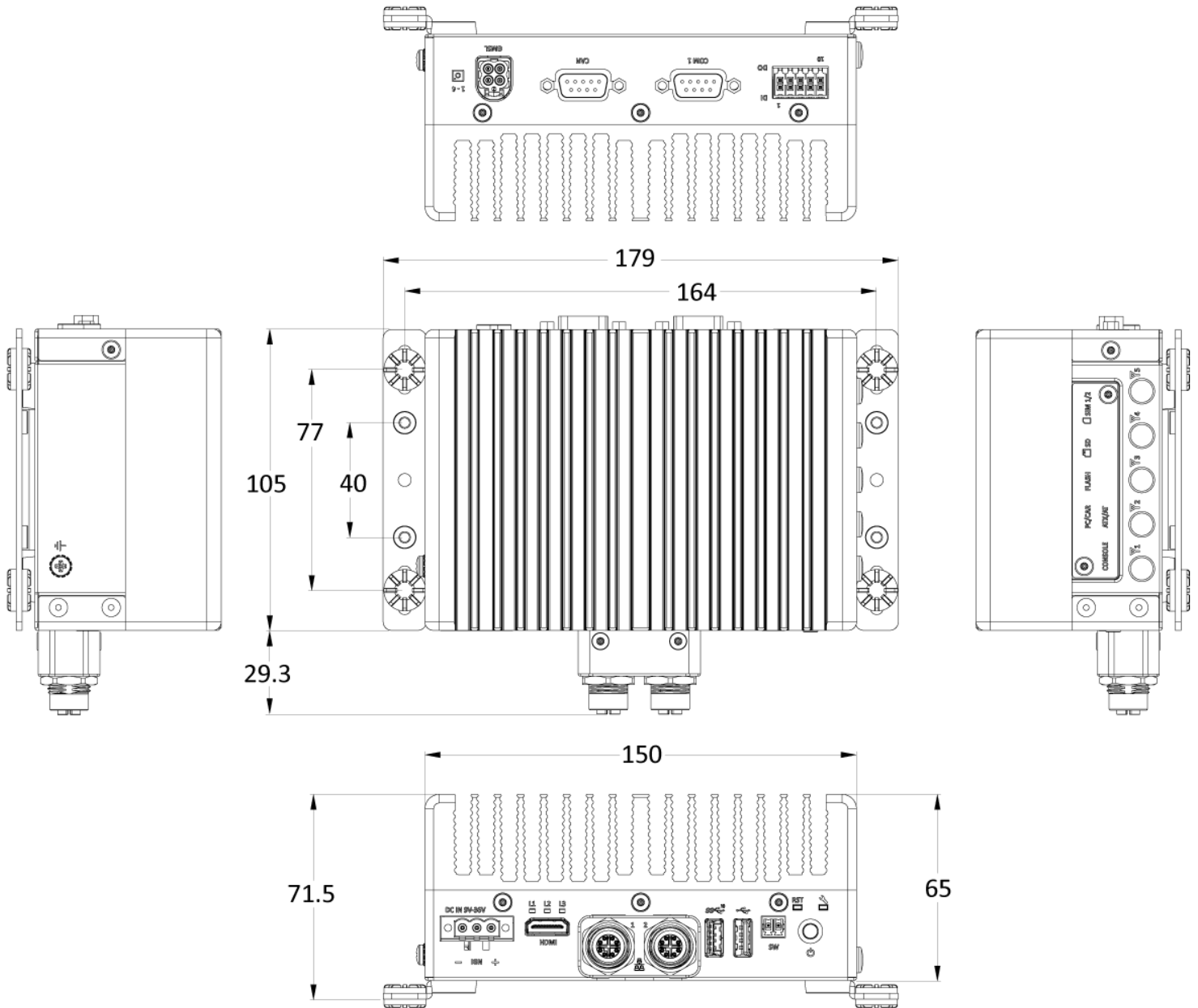

Chapter 2

Mechanical Specifications

2.1 Switch and Connector Locations

2.1.1 Top View

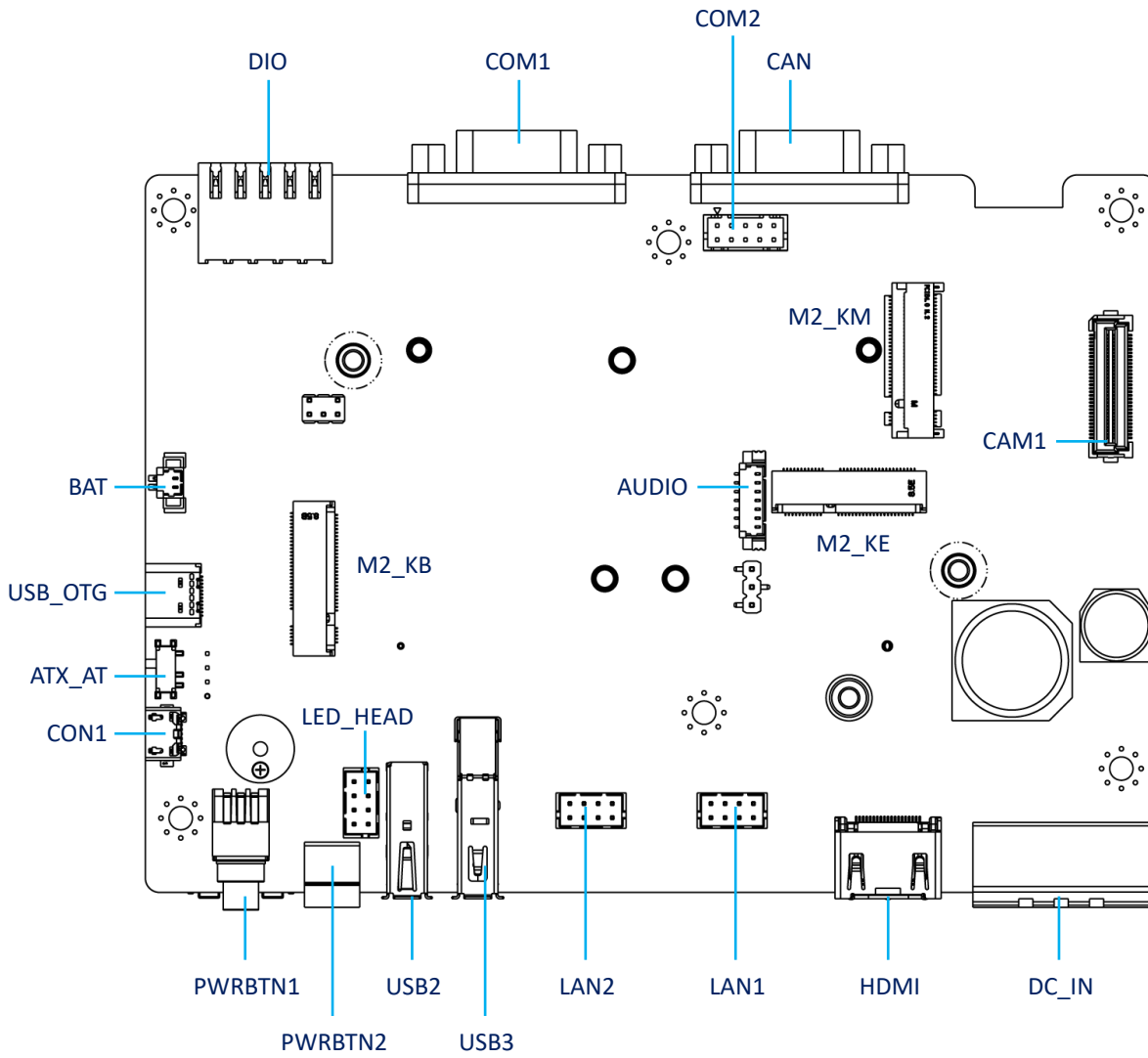

2.1.2 Bottom View

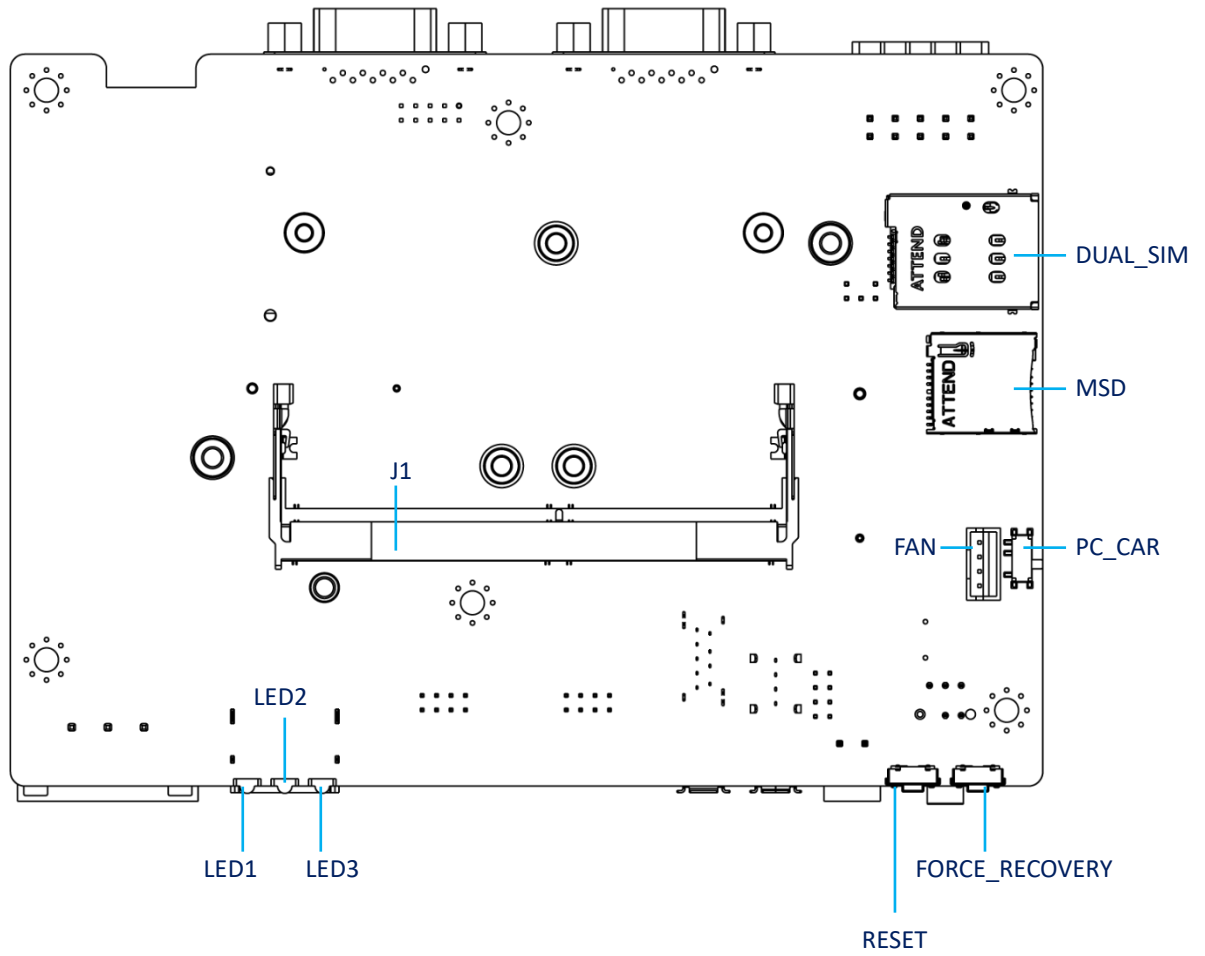

2.2 Connector / Switch Definition

Connector Location	Definition
DC_IN	3 pin Terminal Blocks
HDMI	HDMI Display port
LAN1	1G bit/s LAN Port
LAN2	2.5G bit/s LAN Port
USB3	USB 3.2 Gen 2 Port
USB2	Remote Power Button
PWRBTN2	Remote Power Button
PWRBTN1	Power Button
CON1	Micro USB (Console Port)
ATX_AT	AT_ATX Mode Switch
USB_OTG	USB Type-C (USB 2.0, For Flash OS)
BAT	Battery Wafer
DIO	Digital 4 Input/ 4 Output
COM1	RS232 / RS422 / RS485 Port 1
CAN	CAN Bus Port
LED_HEAD	Power LED Header
M2_KB	M.2 B-Key
COM2	RS232 / RS422 / RS485 Port 2
M2_KM	M.2 M-Key
CAM1	GMSL Connector
M2_KE	M.2 E-Key
AUDIO	Audio Wafer
FORCE_RECOVERY	Force Recovery Button
RESET	Reset Button
LED3	User LED Status
LED2	User LED Status
LED1	User LED Status
J1	CPU Module Slot
DUAL_SIM	SIM Card Dual Socket
MSD	Micro SD Socket
PC_CAR	PC / CAR side Mode Switch
FAN	FAN Connector

2.3 I/O Interface Descriptions

DC Power Input Connector (+9~36V)

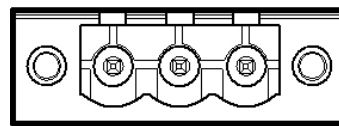
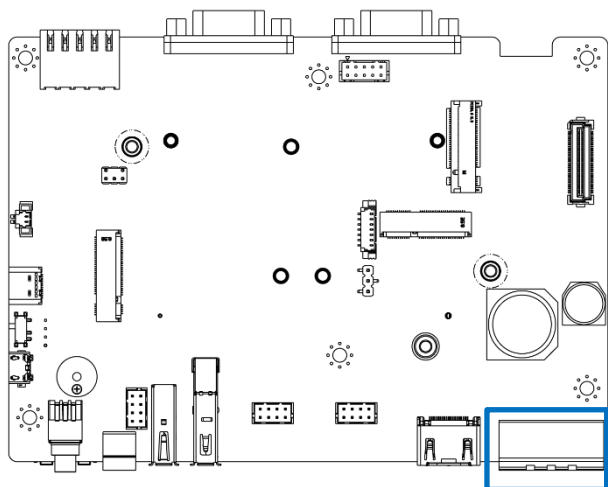

DC_IN1

Pin	Signal
1	+DC_IN
2	IGN
3	GND

HDMI Display Connector

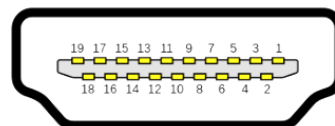
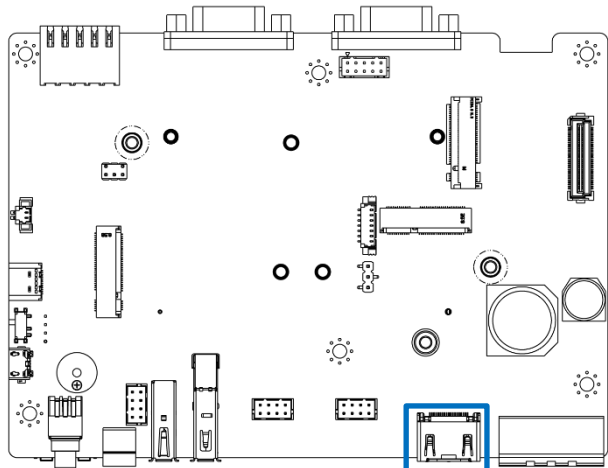

Type A (Receptacle) HDMI

Pin	Definition	Pin	Definition
1	D2+	2	D2 Shield
3	D2-	4	D1+
5	D1_Shield	6	D1-
7	D0+	8	D0 Shield
9	D0-	10	CK+
11	CK Shield	12	CK-
13	CE Remote	14	NC
15	DDC CLK	16	DDC DAT
17	GND	18	5V
19	HDMI_HPDI	20	

RJ45 LAN Port

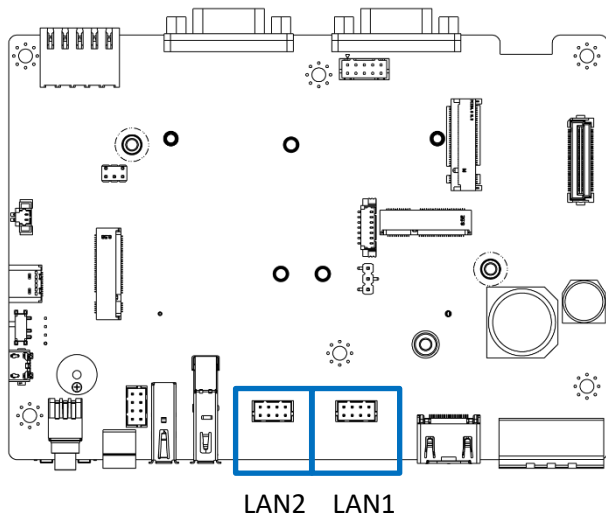

LAN1: Wafer for 1G LAN

Pin	Signal	Pin	Signal
1	J1	2	J2
3	J3	4	J4
5	J5	6	J6
7	J7	8	J8

LAN2 : Wafer for 2.5G LAN

Pin	Signal	Pin	Signal
1	LAN_MDI0P	2	LAN_MDI0N
3	LAN_MDI1P	4	LAN_MDI2P
5	LAN_MDI2N	6	LAN_MDI1N
7	LAN_MDI3P	8	LAN_MDI3N

Remote Power Button

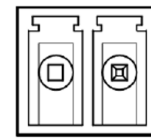
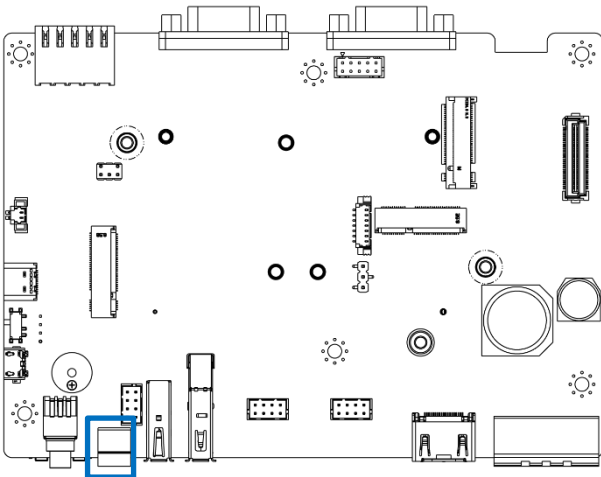

1 2

PWRBTN2

Pin	Signal
1	PWR_SWITCH#
2	GND

Power Button

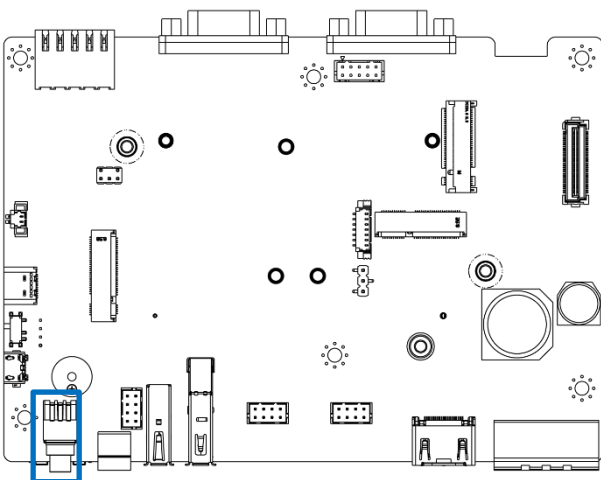

PWRBTN1

Pin	Definition	Pin	Definition
1	NC	4	GND
2	Power Button	5	LED Power
3	NC	6	GND

AT / ATX Power Mode Switch

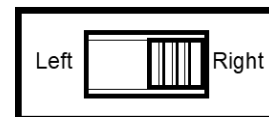
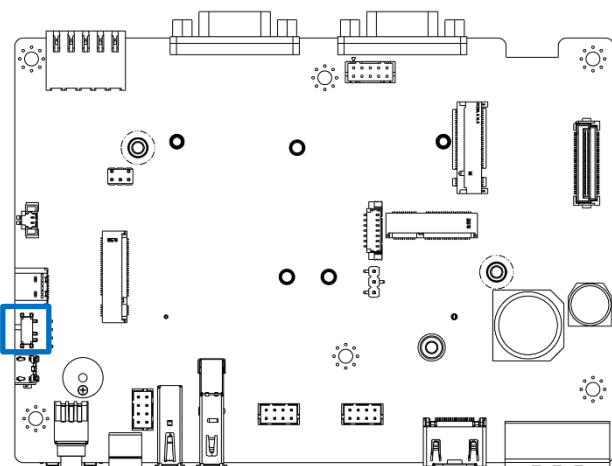

ATX_AT

Pin	Definition
left	AT mode
Right	ATX mode

Console Connector

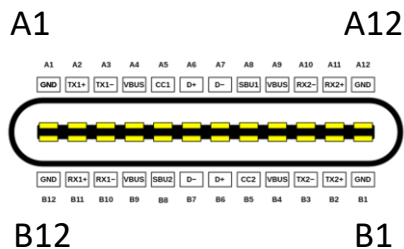
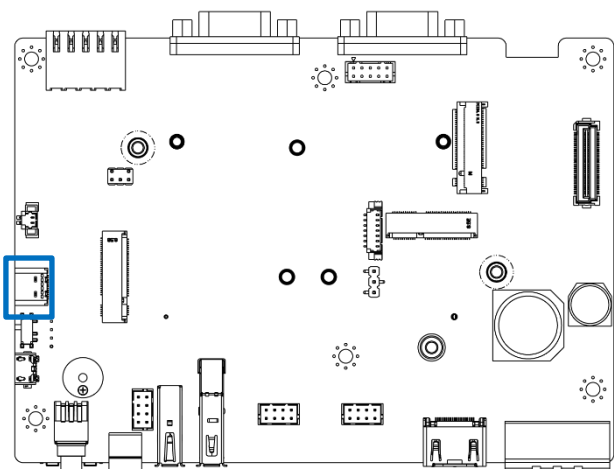

USB_OTG

Pin	Definition
A4,A9 & B4,B9	VBUS +5V
A6 & B6	DP
A7 & B6	DM
A1,A12 & B1,B12	GND
A2,A3,A5,A8,A10,A11	NC
B2,B3,B5,B8,B10,B11	NC

Digital input / Output Connector

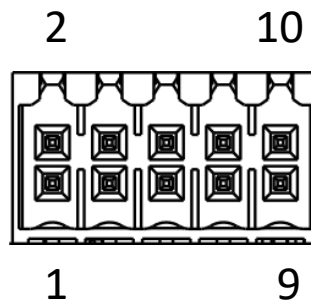
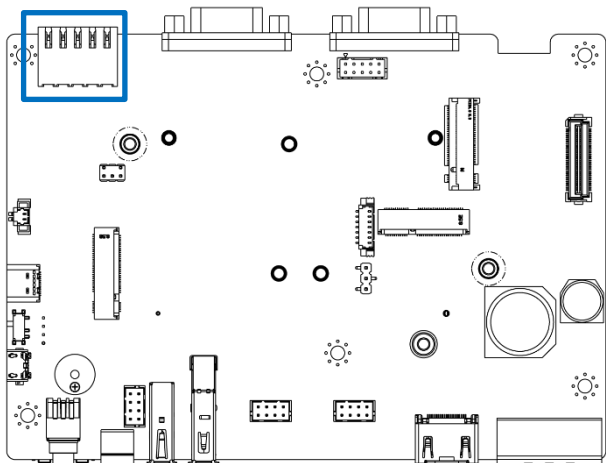

DIO

Pin	Definition	Pin	Definition
1	IN1_1	2	OUT1_1
3	IN2_1	4	OUT2_1
5	IN3_1	6	OUT3_1
7	IN4_1	8	OUT4_1
9	XCOM+_1	18	XCOM-_1

COM1: RS232 / RS422 / RS485 Port 1

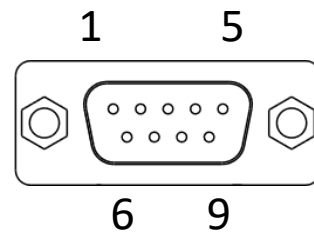
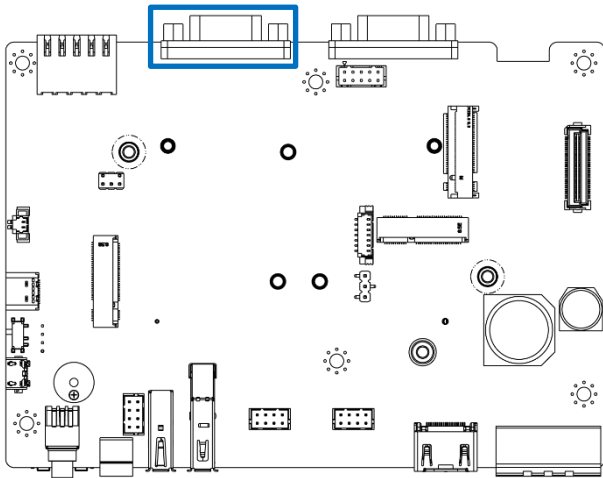

COM1

Pin	Signal
1	DCD (485_422_TX-)
2	RXD (485_422_TX+)
3	TXD (422_RX+)
4	DTR (422_RX-)
5	GND
6	
7	RTS
8	CTS
9	

CAN BUS Connector

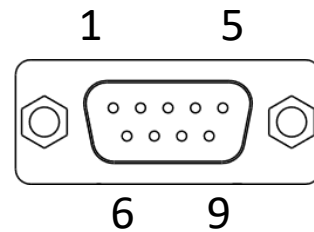
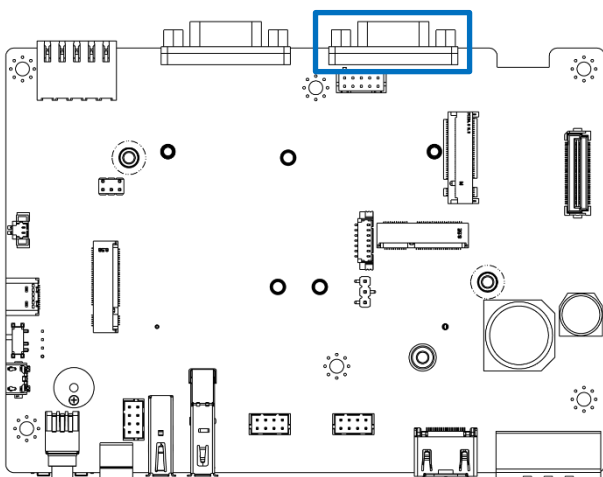

CAN

Pin	Signal
1	
2	CAN1_L
3	
4	
5	GND
6	
7	CAN1_H
8	
9	

Power LED Header

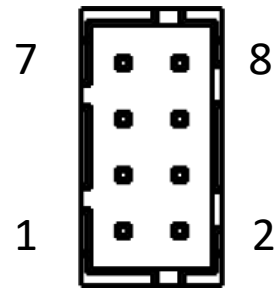
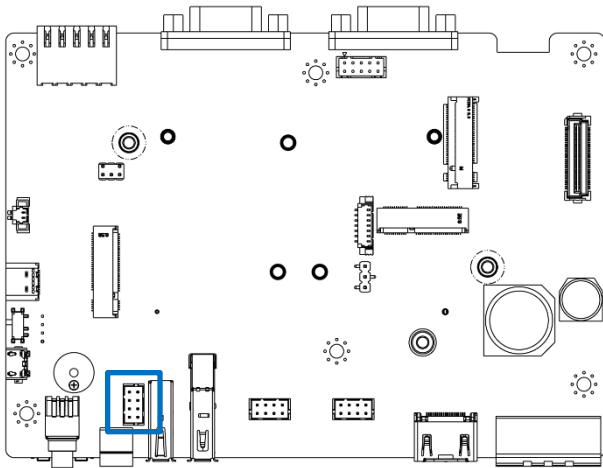

LED_HEAD

Pin	Definition	Pin	Definition
1	Backup button	2	PWR_LED#
3	GND	4	L2_LED#
5	3.3V	6	L3_LED#
7	3.3V	8	L4_LED#

M.2 Key B Socket

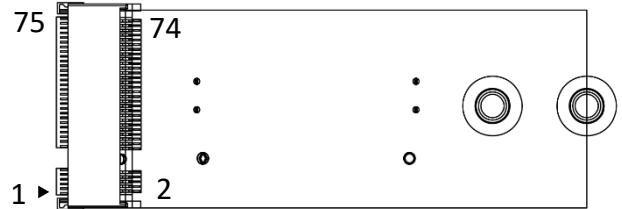
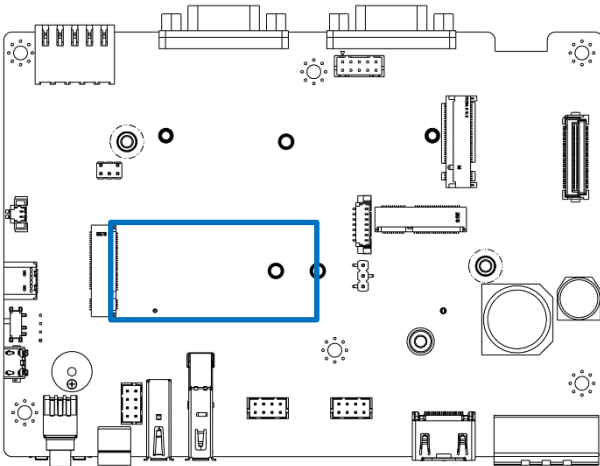

M2_KB

Pin	Definition	Pin	Definition
1	3.3V		
3	GND	2	3.3V
5	GND	4	3.3V
7	USB2_D+	6	Full_card_PWR_OFF#
9	USB2_D-	8	W_Disable1#
11	GND	10	NC
21	NC	20	NC
23	NC	22	NC
25	NC	24	NC
27	GND	26	NC
29	USB3_RX-	28	NC
31	USB3_RX+	30	SIM1_RST
33	GND	32	SIM1_CLK
35	USB3_TX-	34	SIM1_DAT
37	USB3_TX+	36	SIM1_PWR
39	GND	38	NC
41	PCIe_RX-	40	SIM2_DET
43	PCIe_RX+	42	SIM2_DAT

45	GND	44	SIM2_CLK
47	PCle_TX-	46	SIM2_RST
49	PCle_TX+	48	SIM2_PWR
51	GND	50	PCle_RST_N
53	PCle_CLK-	52	PCle_CLKREQ_N
55	PCle_CLK+	54	PCle_WAKE_N
57	GND	56	NC
59	NC	58	NC
61	NC	60	NC
63	NC	62	NC
65	NC	64	NC
67	5G_RST	66	SIM1_DET
69	NC	68	32KHz
71	GND	70	3.3V
73	GND	72	3.3V
75	NC	74	3.3V

COM2: RS232 / RS422 / RS485 Port 2

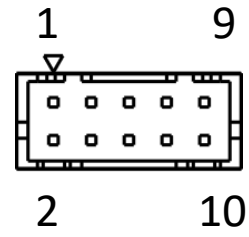
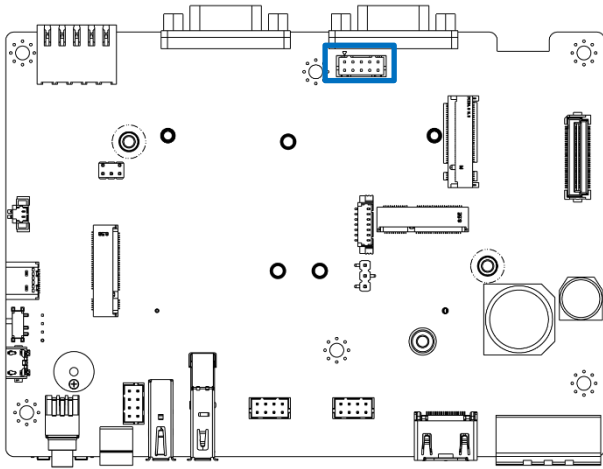

COM1

Pin	Signal
1	DCD (485_422_TX-)
2	
3	RXD (485_422_TX+)
4	RTS
5	TXD (422_RX+)
6	CTS
7	DTR (422_RX-)
8	
9	GND

M.2 Key M Socket

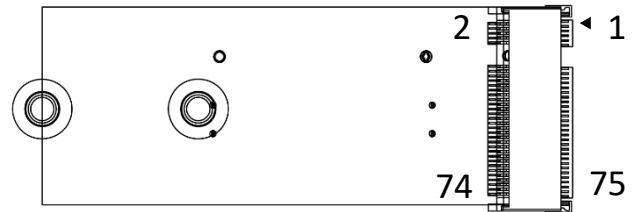
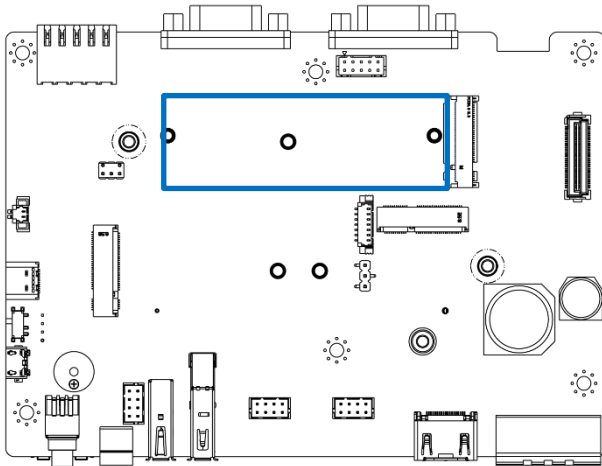

M2_KM

Pin	Definition	Pin	Definition
1	GND	2	3.3V
3	GND	4	3.3V
5	PCIe_RX3-	6	NC
7	PCIe_RX3+	8	NC
9	GND	10	NC
11	PCIe_TX3-	12	3.3V
13	PCIe_TX3+	14	3.3V
15	GND	16	3.3V
17	PCIe_RX2-	18	3.3V
19	PCIe_RX2+	20	NC
21	GND	22	NC
23	PCIe_TX2-	24	NC
25	PCIe_TX2+	26	NC
27	GND	28	NC
29	PCIe_RX1-	30	NC
31	PCIe_RX1+	32	NC
33	GND	34	NC
35	PCIe_TX1-	36	NC
37	PCIe_TX1+	38	NC

39	GND	40	I2C_SCL
41	PCIe_RX0-	42	I2C_SDA
43	PCIe_RX0+	44	M2 ALERT
45	GND	46	NC
47	PCIe_TX0-	48	NC
49	PCIe_TX0+	50	PCI_RST#
51	GND	52	PCIe_CLKREQ#
53	PCIe_CLK-	54	PCIe_WAKE#
55	PCIe_CLK+	56	NC
57	GND	58	NC
67	NC	68	SUSCLK
69	NC	70	3.3V
71	GND	72	3.3V
73	GND	74	3.3V
75	GND		

GMSL Connector

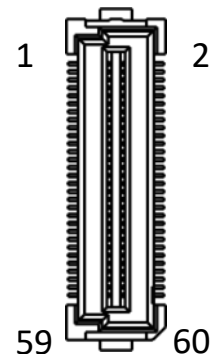
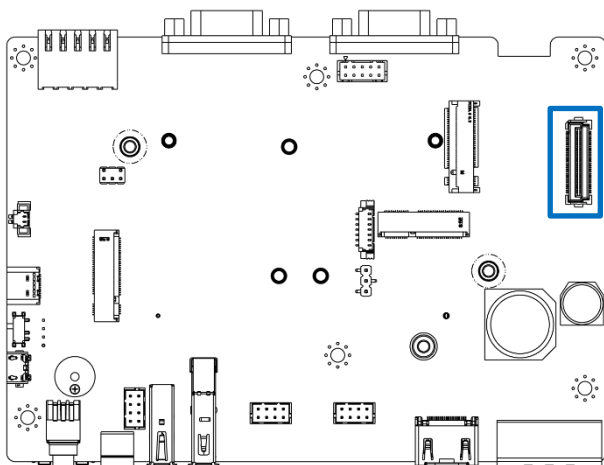

CAM1

Pin	Signal	Pin	Signal
1	CSI3_D0_P	2	CSI1_D0_P
3	CSI3_D0_N	4	CSI1_D0_N
5	GND	6	GND
7	CSI3_CLK_P	8	CSI1_CLK_P
9	CSI3_CLK_N	10	CSI1_CLK_N
11	GND	12	GND
13	CSI3_D1_P	14	CSI1_D1_P
15	CSI3_D1_N	16	CSI1_D1_N
17	GND	18	GND
19	CSI2_D0_P	20	CSI0_D0_P
21	CSI2_D0_N	22	CSI0_D0_N
23	GND	24	GND
25	CSI2_CLK_P	26	CSI0_CLK_P
27	CSI2_CLK_N	28	CSI0_CLK_N
29	GND	30	GND
31	CSI2_D1_P	32	CSI0_D1_P
33	CSI2_D1_N	34	CSI0_D1_N
35	GND	36	GND
37	CAM_I2C_SCL	38	CAM0_PWEN_3V3
39	CAM_I2C_SDA	40	CAMFRSYNC1
41	GND	42	CAMFRSYNC2
43	+1.8V	44	CAMERROR1
45	+1.8V	46	CAMERROR2
47	GND	48	GND
49	+1.2V	50	+3.3V
51	+1.2V	52	+3.3V
53	GND	54	GND
55	GND	56	GND
57	+12V	58	+12V
59	+12V	60	+12V

M.2 Key E Socket

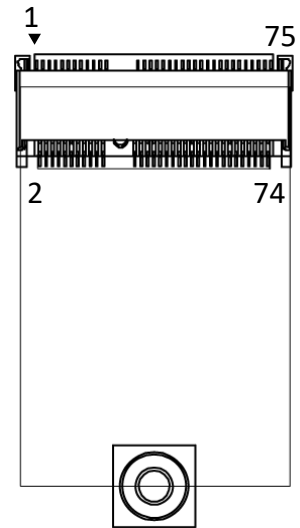
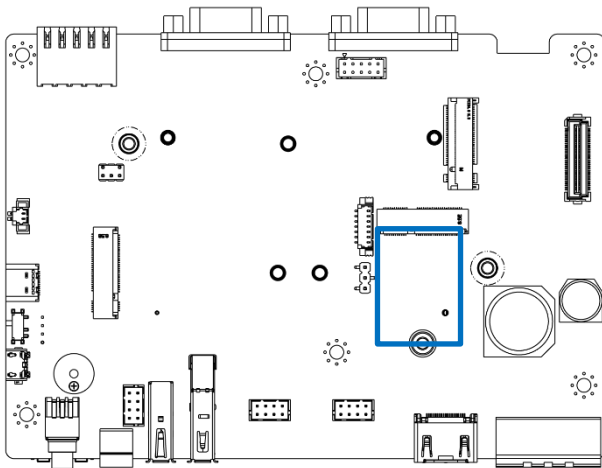

M2_KE

Pin	Definition	Pin	Definition
1	GND		
3	USB2_D+	2	3.3V
5	USB2_D-	4	3.3V
7	GND	6	NC
9	NC	8	I2S_SCLK
11	NC	10	I2S_LRCK
13	NC	12	I2S_SDIN
15	NC	14	I2S_SDOUT
17	NC	16	NC
19	NC	18	GND
21	NC	20	BT_WAKE
23	NC	22	NC
33	GND	32	NC
35	PCIe_TX+	34	NC
37	PCIe_TX-	36	NC
39	GND	38	NC
41	PCIe_RX+	40	NC
43	PCIe_RX-	42	NC

45	GND	44	NC
47	PCIe_CLK+	46	NC
49	PCIe_CLK-	48	NC
51	GND	50	32 KHz
53	PCIe_CLKREQ#	52	PCIe_RST
55	PCIe_WAKE#	54	W_Disable2#
57	GND	56	W_Disable1#
59	NC	58	I2C_SDA
61	NC	60	I2C_SCL
63	GND	62	M2E_Alert#
65	NC	64	NC
67	NC	66	NC
69	GND	68	NC
71	NC	70	NC
73	NC	72	3.3V
75	GND	74	3.3V

Audio Wafer

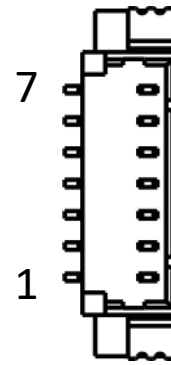
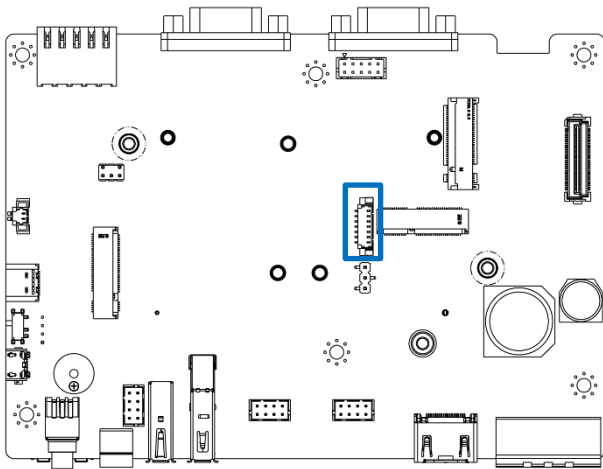

AUDIO

DB9 Pin	CAN BUS
1	LINE_OUT_L/Head Ouput_L
2	LINE_OUT_R/Head Ouput_R
3	Audio GND
4	Audio GND
5	Audio GND
6	LINE_IN_L/MIC_IN
7	LINE_IN_R

SIM Card Dual Socket

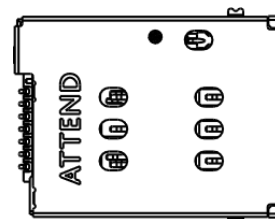
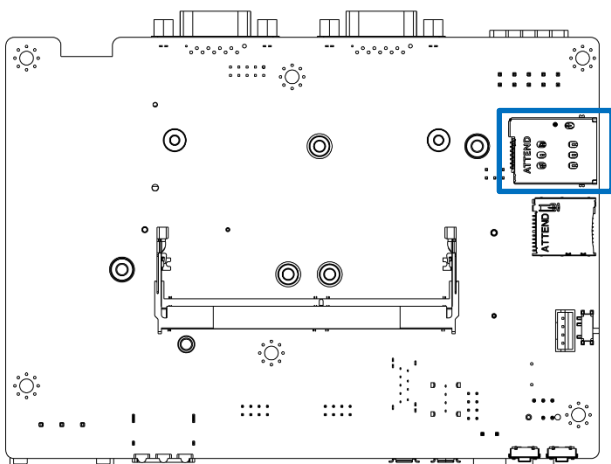

DUAL_SIM

Pin (SIM1/2)	Definition
C1/C8	PWR
C2/C9	RST
C3/C10	CLK
C5/C12	GND
C6/C13	VPP
C7/C14	I/O
CD1/CD2	Card Detect Switch

Micro SD socket

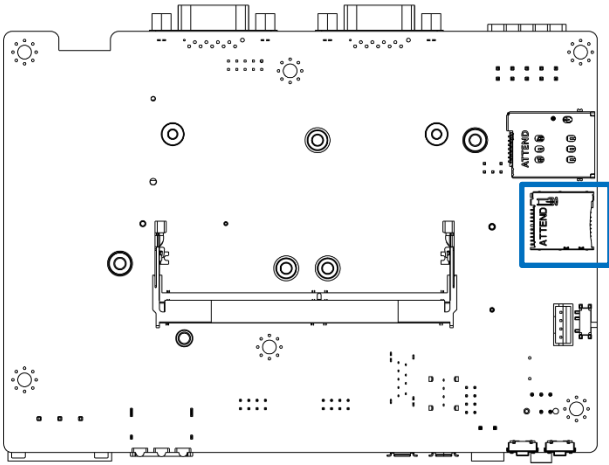

MSD

Pin	Definition	Pin	Definition
1	SDMMC_D2	9	NC
2	SDMMC_D3	10	GND
3	SDMMC_CMD	11	NC
4	3.3V	12	NC
5	SDMMC_CLK	13	GND
CD	SDMMC_DET	14	NC
6	GND	15	NC
7	SDMMC_D0	16	GND
8	SDMMC_D1	17	NC

PC / CAR side Mode Switch

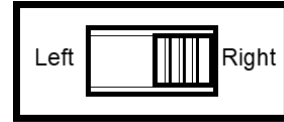
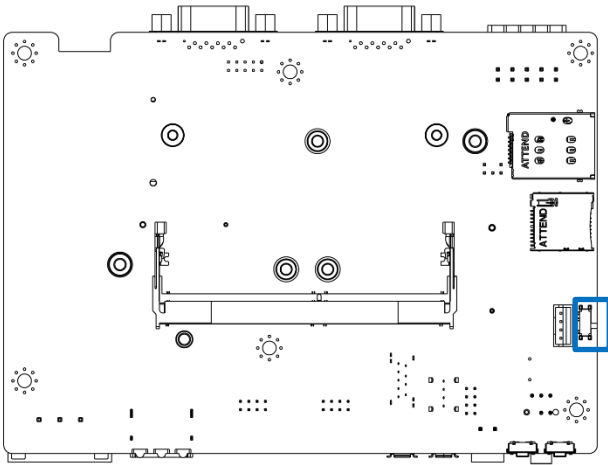

PC_CAR

Pin	Definition
Left	PC mode (Default)
Right	Car mode

Fan Connector

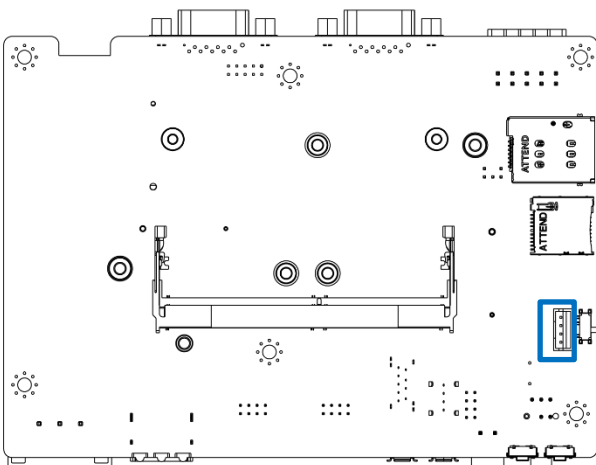

FAN

Pin	Signal
1	GND
2	+12V
3	FAN_TACH
4	FAN_PWM

Chapter 3

System Setup

3.1 Set torque force to 3.5 kgf-cm to screw or unscrew system parts.

**WARNING**

To ensure safety and prevent system damage, please switch off the system and disconnect it from its power source before disassembly.

3.2 Removing the upper cover

1. Turn the computer upside down. Remove the four screws on the bottom cover, as highlighted in the picture below.

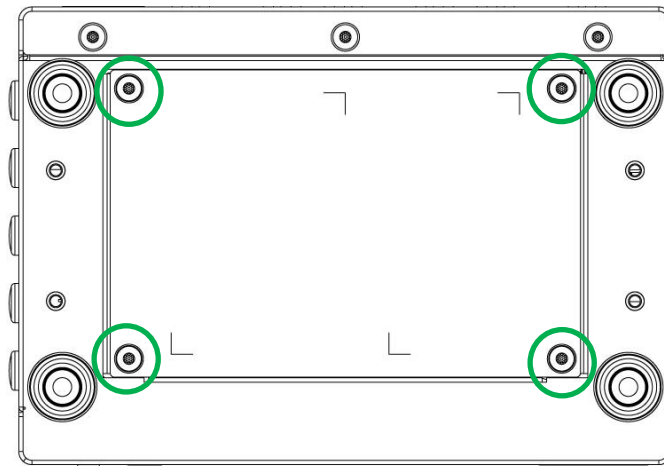

2. Now you can remove the bottom cover.

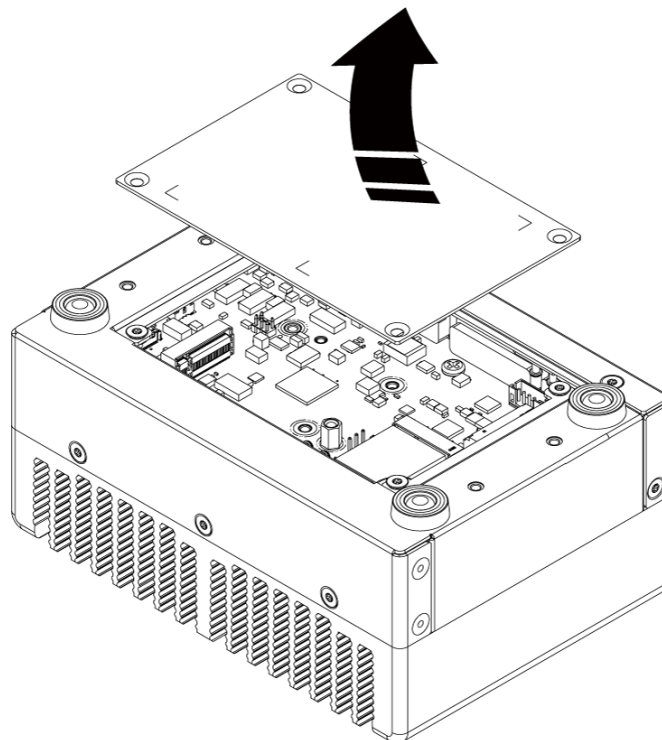

3.3 Install M.2 M Key Socket

The M.2 M Key slot supports NVMe SSD, as highlighted in the picture below.

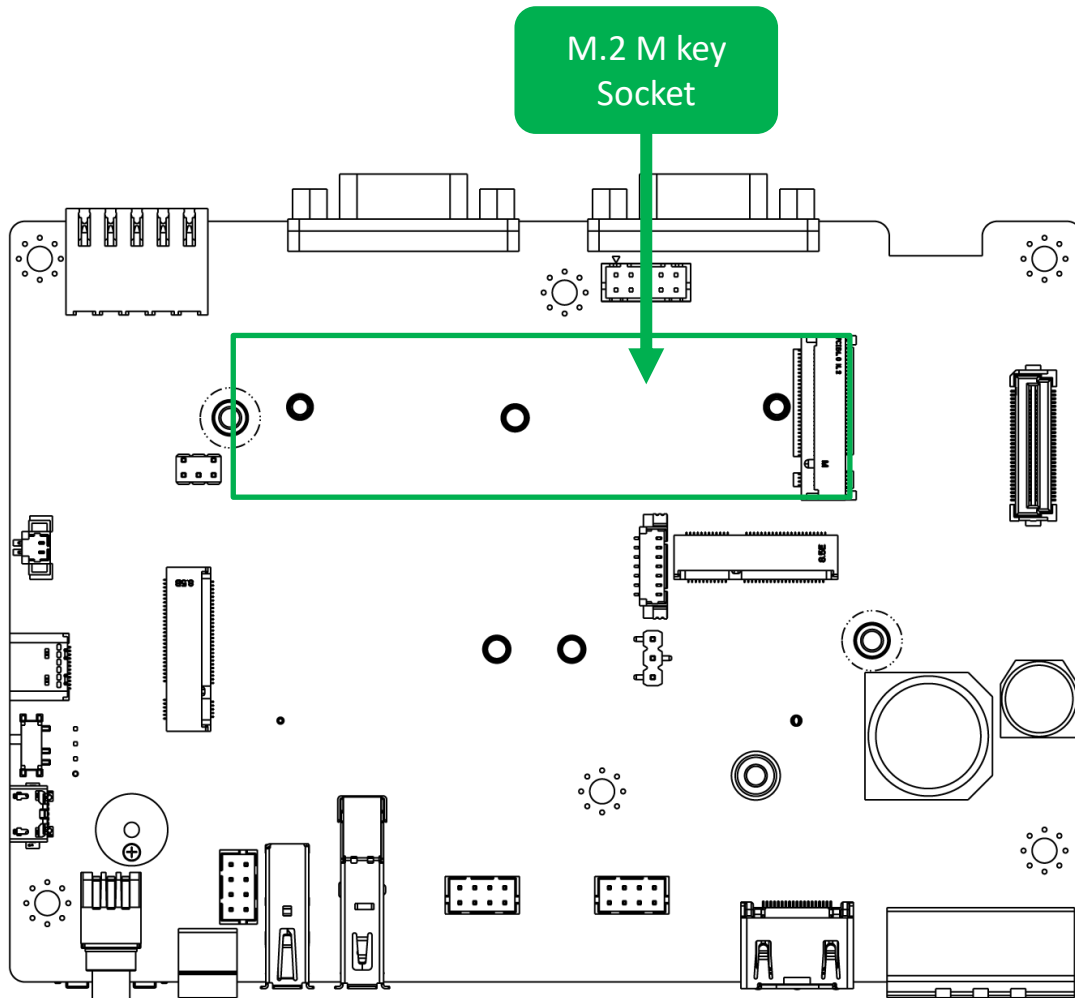

Install M.2 M Key NVMe SSD Step by Step

1. Assemble the copper stud

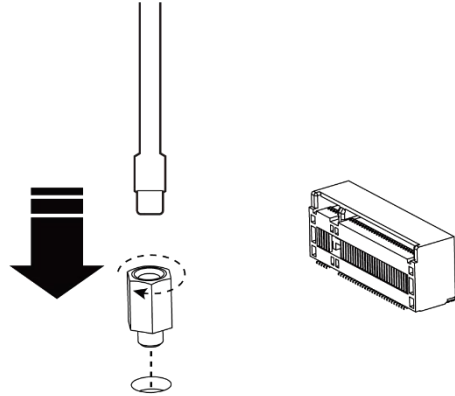

2. Insert the NVMe SSD at a 45-degree angle into the M.2 B-Key slot.

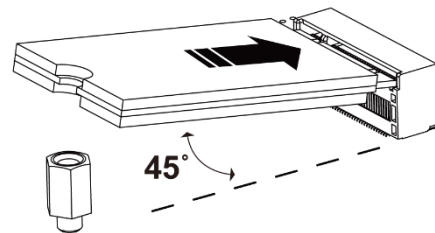

3. Press the NVMe SSD down and secure it with one screw.

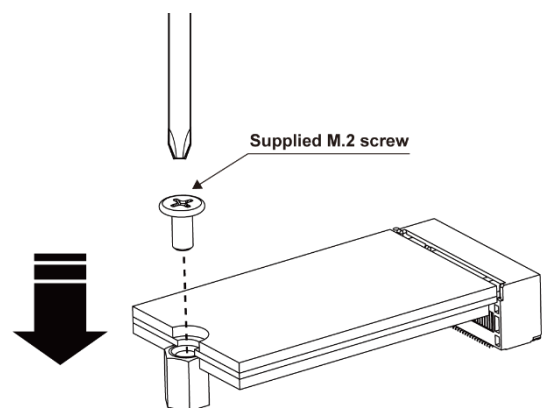

3.4 Install M.2 B Key Communication Module and Antenna

The M.2 B-Key supports communication (4G/5G) module, as highlighted in the picture below.

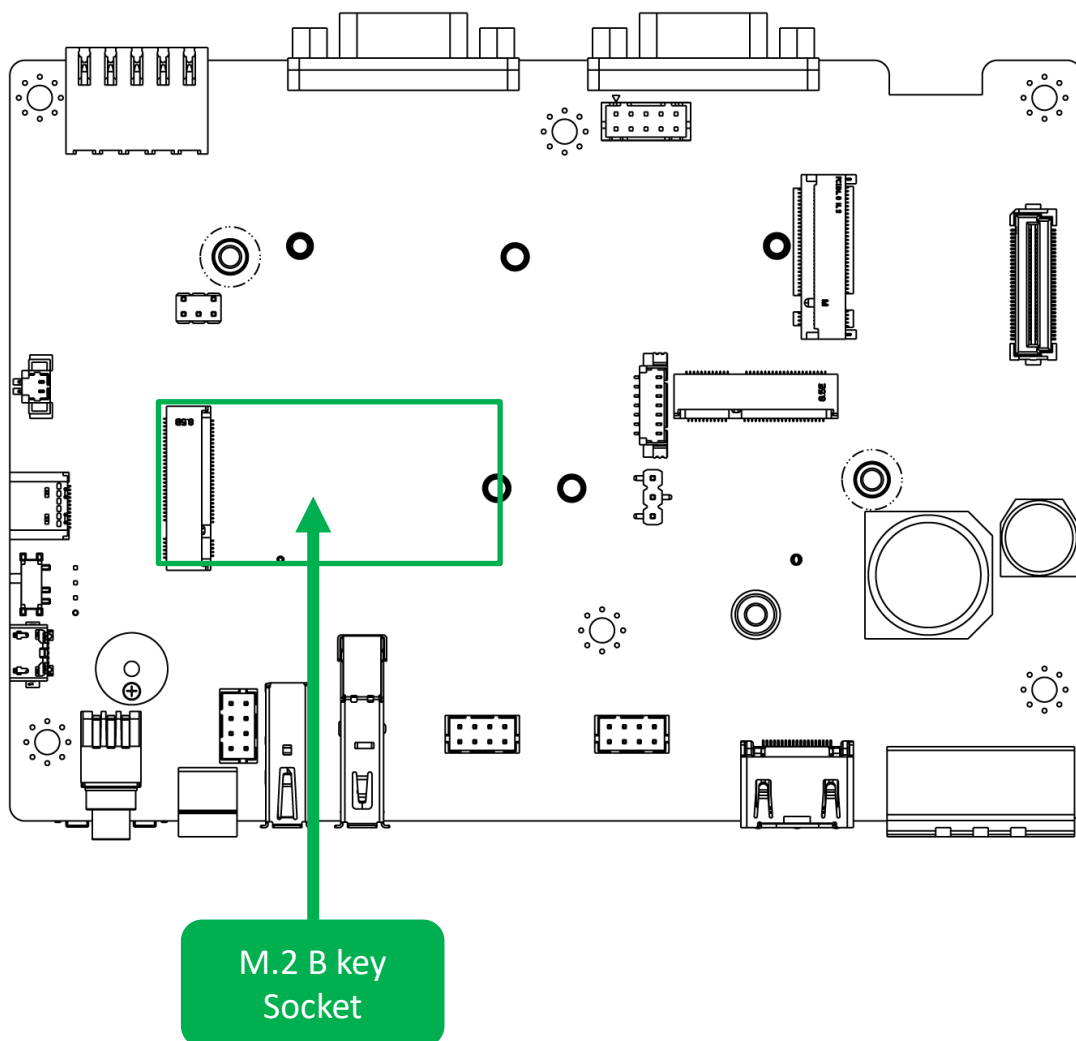

Install M.2 B Key (4G/5G) module Step by Step

1. Connect the SMA cables to the communication (4G/5G) module.

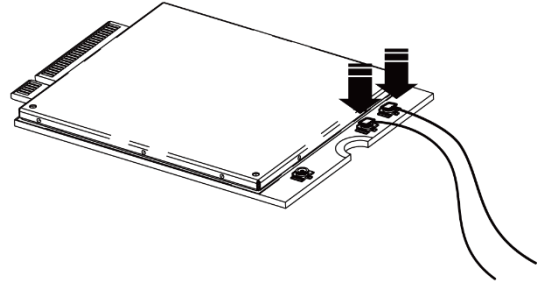

2. Insert the communication (4G/5G) module at a 45-degree angle.

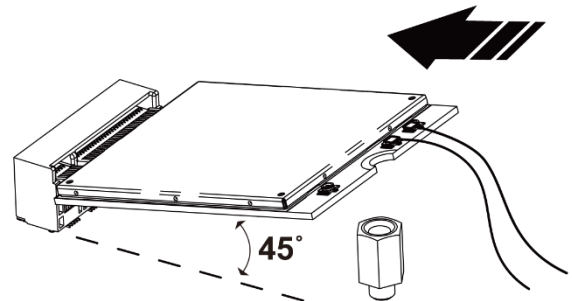

3. Press the communication module down and secure it with one screw.

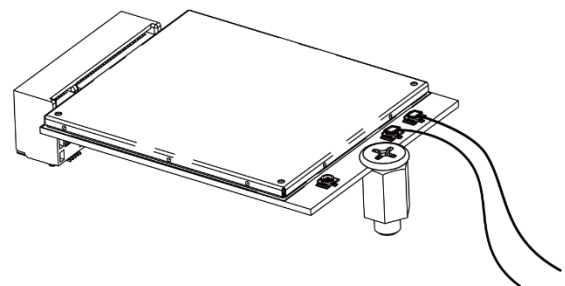
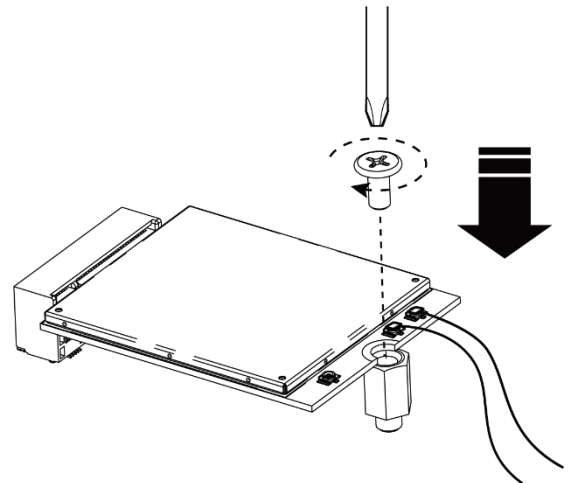

- 4. Assemble the antenna and SMA jack together; the outcome should resemble the picture below.

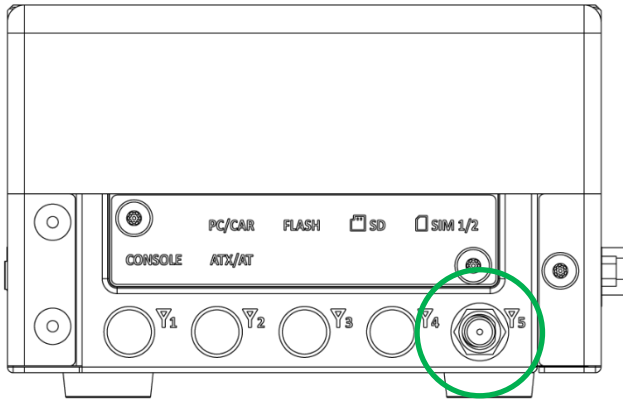

Attach the cable end of the wireless RF connector to the communication module.

Assemble the antenna and SMA jack together

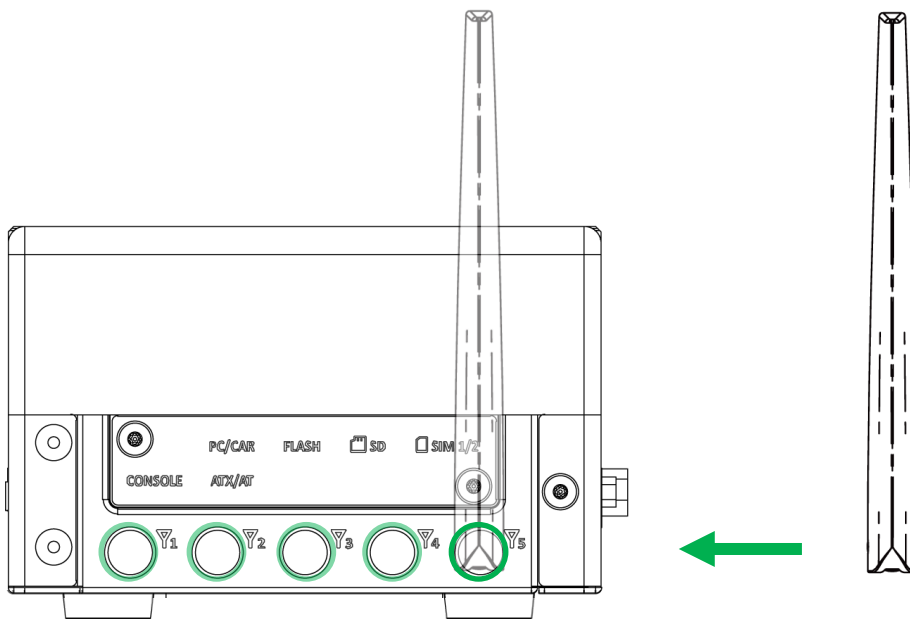

3.5 Install M.2 E Key Wi-Fi and Antenna

The M.2 E-Key supports Wi-Fi module, , as highlighted in the picture below.

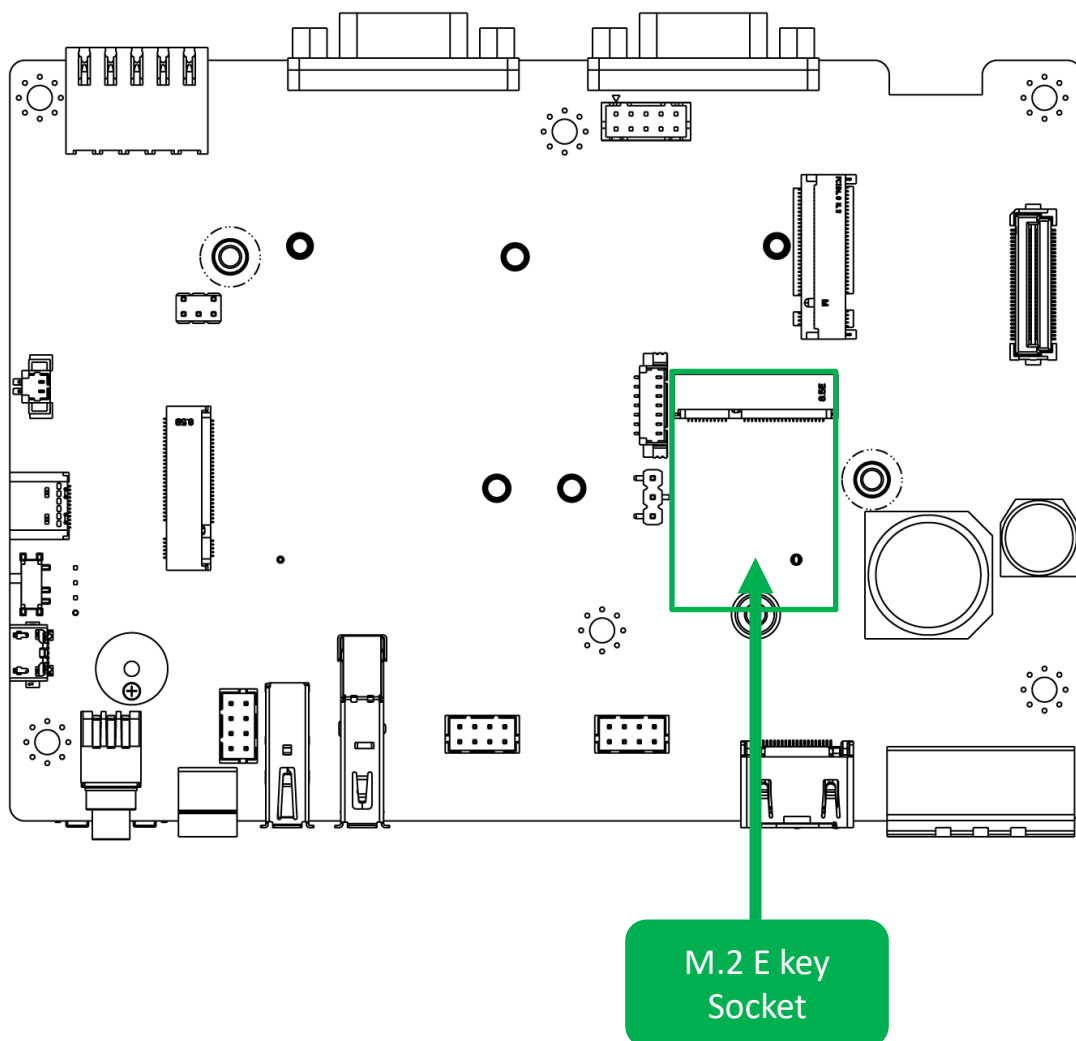

Install M.2 E Key Wi-Fi module Step by Step

1. Connect the SMA cables to the Wi-Fi module.

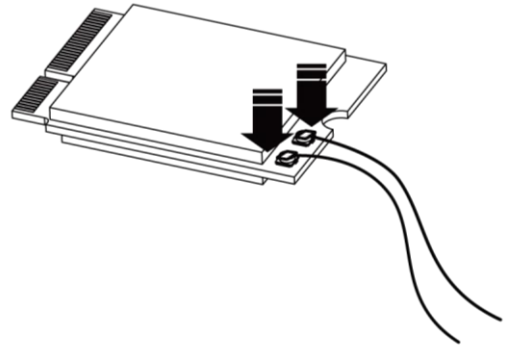

2. Insert the Wi-Fi module at a 45-degree angle.

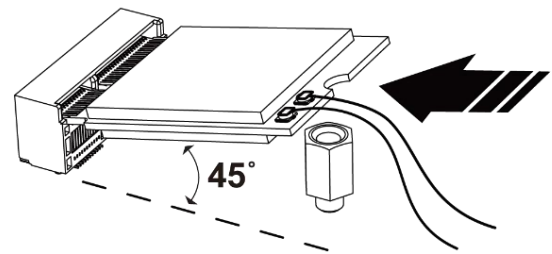

3. Press the Wi-Fi module down and secure it with one screw.

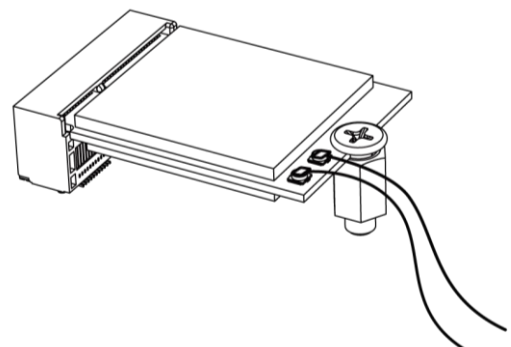
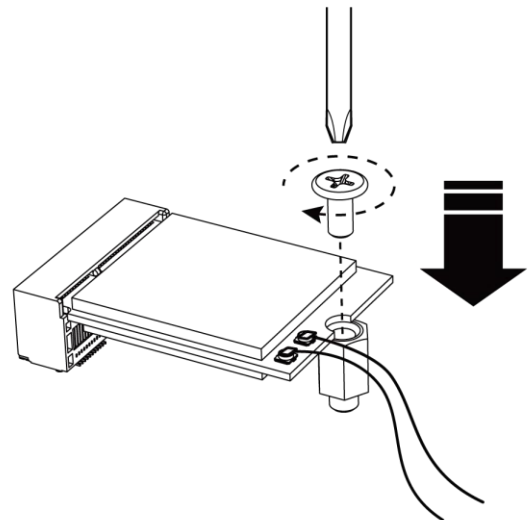

4. Assemble the antenna and SMA jack together; the outcome should resemble the picture below.

Attach the cable end of the wireless RF connector to the communication module.

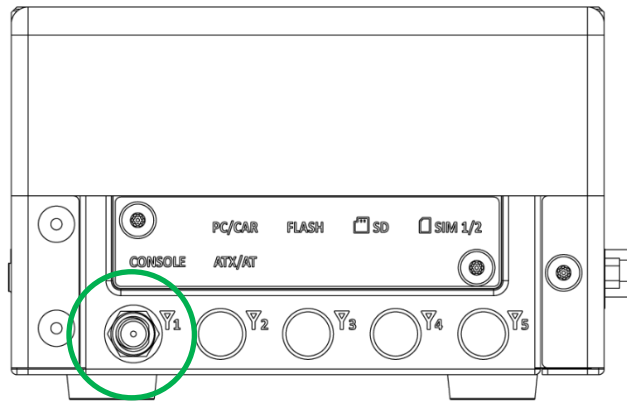

Assemble the antenna and SMA jack together

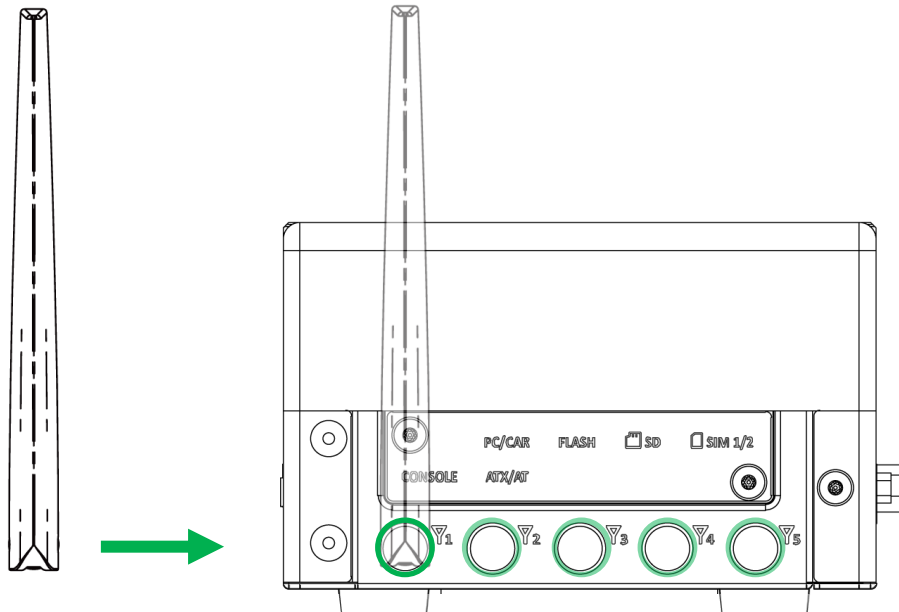

3.6 Installing Wall Mount

1. Wall Mount holder is available for JCO-1000-ORN series.

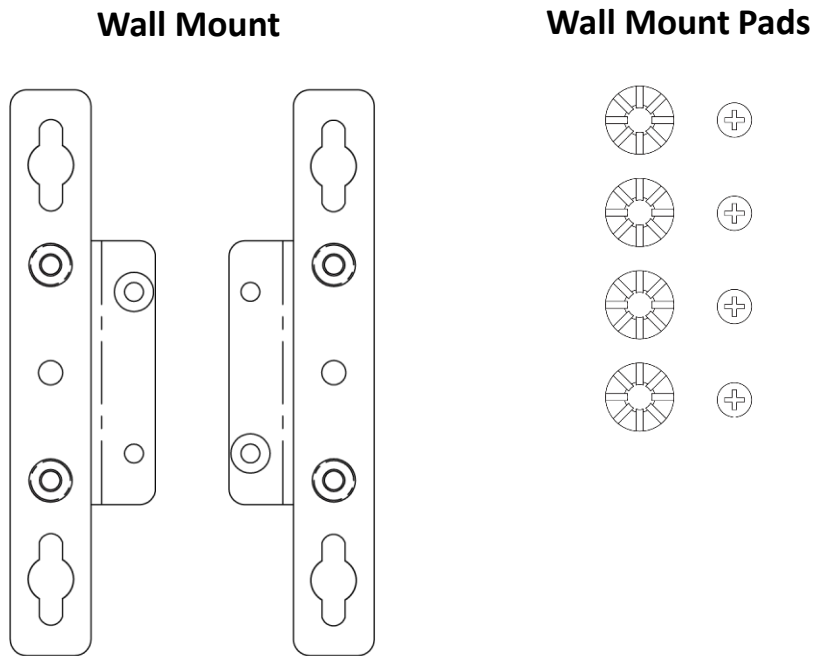

2. Assemble the anti-vibration grommets and screws together.

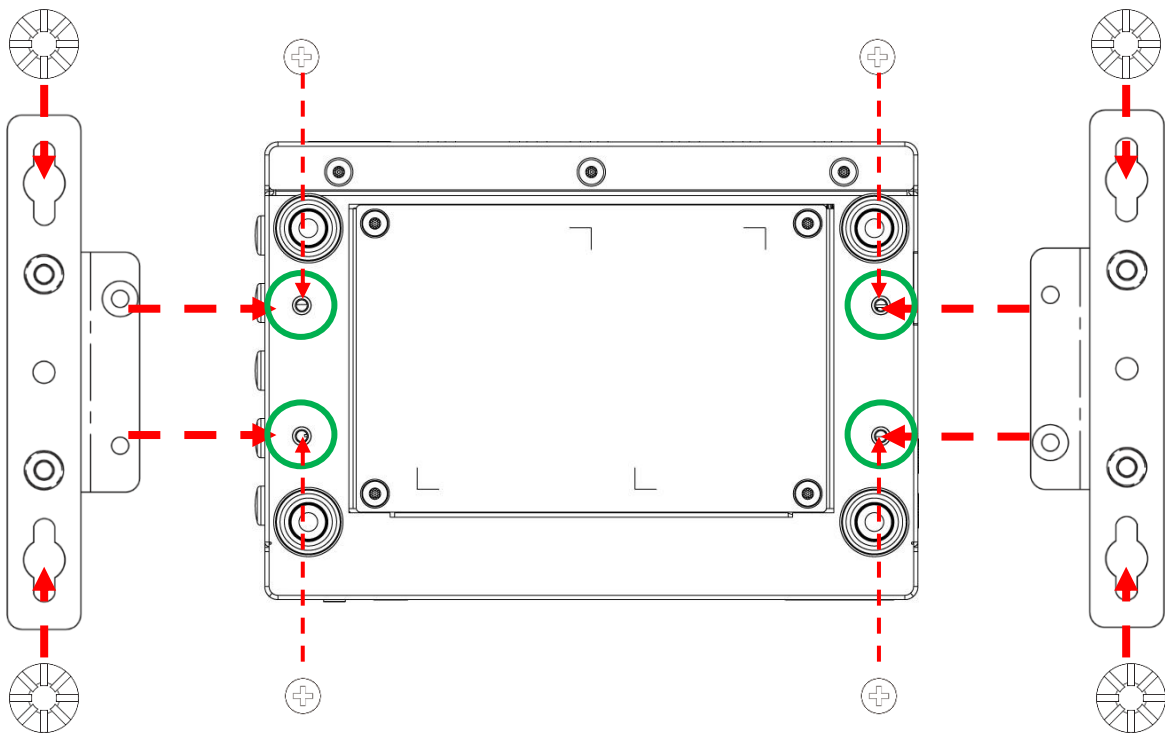

Chapter 4

Software Setup Guide

4.1 OS Flash Image Guide

4.1.1 Preparation

Host PC:

You need a host PC running Ubuntu Desktop 20.04. And need install below package:

```
sudo apt-get install qemu-user-static
sudo apt-get install sshpass
sudo apt-get install abooting
sudo apt install nfs-kernel-server
sudo apt-get install libxml2-utils
sudo apt-get install zstd
sudo apt-get install binutils
```

- **BSP Image:**
For BSP image download, please contact your distributor, our technical support team, or sales representative. The file name will follow the format of :

{Model}_{JetPack_Ver}_{BSP_Ver}.tar.gz

For Example:

JCO-1000-ORN-C_JP62_V1.3.1.tar.gz

- **BSP Image file MD5 checksum verification:**
For BSP image download, please contact your distributor, our technical support team, or sales representative. The file name will follow the format of:

{Model}_{JetPack_Ver}_{BSP_Ver}.tar.gz.md5.txt

For Example:

JCO-1000-ORN-C_JP62_V1.3.1.tar.gz.md5.txt

On Host Computer, open Linux terminal and enter the following command to check the BSP image file checksum is correct:

```
$ md5sum ./JCO-1000-ORN-C_JP62_V1.3.1.tar.gz
$ cat ./JCO-1000-ORN-C_JP62_V1.3.1.tar.gz.md5.txt
```

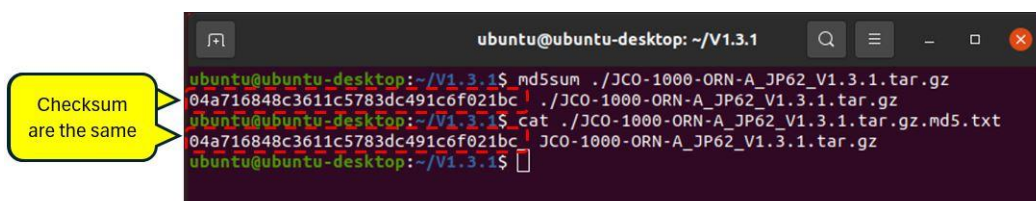

```
ubuntu@ubuntu-desktop: ~/V1.3.1
ubuntu@ubuntu-desktop:~/V1.3.1$ md5sum ./JCO-1000-ORN-A_JP62_V1.3.1.tar.gz
04a716848c3611c5783dc491c6f021bc ./JCO-1000-ORN-A_JP62_V1.3.1.tar.gz
ubuntu@ubuntu-desktop:~/V1.3.1$ cat ./JCO-1000-ORN-A_JP62_V1.3.1.tar.gz.md5.txt
04a716848c3611c5783dc491c6f021bc JCO-1000-ORN-A_JP62_V1.3.1.tar.gz
ubuntu@ubuntu-desktop:~/V1.3.1$
```

4.1.2 Flash BSP Image

On Host Computer, open Linux terminal and enter the following command to extract compressed OS image files (file name may vary):

```
$ sudo tar zxvf JCO-1000-ORN-C_JP62_V1.3.1.tar.gz
```

Next, following steps to force the system to start in USB Recovery Mode:

1. Connect the USB type-C cable to the “Flash” port on the JCO-1000-ORN-C and the USB port on the host PC.

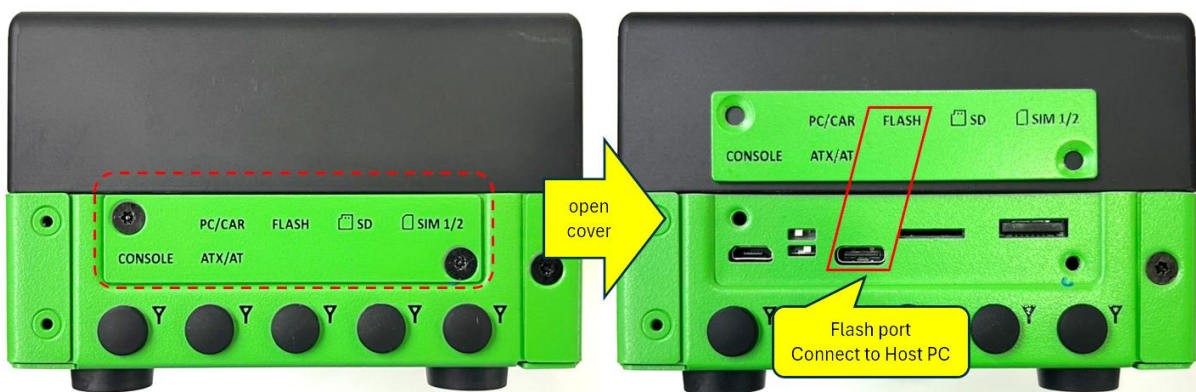

2. Press and hold force recovery button, then press power button on the system. Wait for two seconds then release the buttons.



3. When device is in recovery mode, lsusb command on host PC will list a line of “0955:7323 Nvidia Corp”

```
ubuntu@ubuntu-desktop: ~
ubuntu@ubuntu-desktop:~$ lsusb
Bus 002 Device 005: ID 046b:ff10 American Megatrends, Inc. Virtual Keyboard and Mouse
Bus 002 Device 004: ID 046b:ff01 American Megatrends, Inc.
Bus 001 Device 009: ID 0955:7323 NVIDIA Corp.
Bus 001 Device 002: ID 8087:0024 Intel Corp. Integrated Rate Matching Hub
Bus 001 Device 001: ID 1d6b:0002 Linux Foundation 2.0 root hub
ubuntu@ubuntu-desktop:~$
```

Next, following steps to flash BSP image in JCO-1000-ORN-C :

1. Open terminal on Ubuntu host PC, then access the bootloader folder you extracted in the previous section.
2. Enter the following command in terminal to flash the image:

```
$ sudo ./flash-jco-1000.sh
```

3. Wait as the image is installed. Once finished you should see the following:

```
[ 330.1043 ] [.....] 100%
[ 330.1145 ] Writing partition B_bmp-fw with bmp_t234-TE990M-A1_prod_sigheader.bin.encrypt [ 1051136 bytes ]
[ 332.1415 ] [.....] 100%
[ 345.0480 ] Writing partition B_bmp-fw-dtb with tegra234-bmp-3701-0004-3737-0000_with_odm_sigheader.dtb.encrypt [ 260160 bytes ]
[ 345.0835 ] [.....] 100%
[ 345.0970 ] Writing partition B_psc-fw with pscfw_t234_prod_sigheader.bin.encrypt [ 375168 bytes ]
[ 348.3002 ] [.....] 100%
[ 348.3182 ] Writing partition B_mts-nce with nce_flash_o10_cr_prod_sigheader.bin.encrypt [ 190592 bytes ]
[ 352.9279 ] [.....] 100%
[ 352.9392 ] Writing partition B_sc7 with sc7_t234_prod_sigheader.bin.encrypt [ 184544 bytes ]
[ 355.2881 ] [.....] 100%
[ 355.2989 ] Writing partition B_pscr with pscr_t234_prod_sigheader.bin.encrypt [ 122320 bytes ]
[ 357.5720 ] [.....] 100%
[ 357.5805 ] Writing partition B_mb2rf with mb2rf_t234_sigheader.bin.encrypt [ 122752 bytes ]
[ 359.0880 ] [.....] 100%
[ 359.0972 ] Writing partition B_cpu-bootloader with uefi_jetson_with_dtb_sigheader.bin.encrypt [ 3031104 bytes ]
[ 360.6112 ] [.....] 100%
[ 386.4523 ] Writing partition B_secure-os with tos-optee_t234_sigheader.img.encrypt [ 1127568 bytes ]
[ 397.9181 ] [.....] 100%
[ 410.8291 ] Writing partition B_eks with eks_t234_sigheader.img.encrypt [ 9232 bytes ]
[ 411.8079 ] [.....] 100%
[ 411.8127 ] Writing partition B_dce-fw with display-t234-dce_with_kernel_tegra234-p3701-0004-p3737-0000_aligned_blob_w_bin_sigheader.bin.encrypt [ 747936 bytes ]
[ 411.9398 ] [.....] 100%
[ 411.9721 ] Writing partition B_spe-fw with spe_t234_sigheader.bin.encrypt [ 270336 bytes ]
[ 421.1525 ] [.....] 100%
[ 421.1660 ] Writing partition B_rce-fw with camera-rtcpu-t234-rce_sigheader.img.encrypt [ 537952 bytes ]
[ 424.4859 ] [.....] 100%
[ 424.5101 ] Writing partition B_adsp-fw with adsp-fw_sigheader.bin.encrypt [ 400864 bytes ]
[ 431.1165 ] [.....] 100%
[ 431.1334 ] Writing partition B_VER with qspl_bootblob_ver.txt [ 109 bytes ]
[ 436.0570 ] [.....] 100%
[ 436.0616 ] Writing partition A_VER with qspl_bootblob_ver.txt [ 109 bytes ]
[ 436.0717 ] [.....] 100%
[ 436.0765 ] Writing partition master_boot_record with mbr_1_3.bin [ 512 bytes ]
[ 436.0870 ] [.....] 100%
[ 436.0913 ] Writing partition A_kernel with boot.img [ 43489280 bytes ]
[ 436.0975 ] [.....] 100%
[ 437.9265 ] Writing partition A_kernel-dtb with kernel_tegra234-p3701-0004-p3737-0000.dtb [ 378167 bytes ]
[ 437.9319 ] [.....] 100%
[ 437.9493 ] Writing partition B_kernel with boot.img [ 43489280 bytes ]
[ 437.9543 ] [.....] 100%
[ 439.8495 ] Writing partition B_kernel-dtb with kernel_tegra234-p3701-0004-p3737-0000.dtb [ 378167 bytes ]
[ 439.8548 ] [.....] 100%
[ 439.8730 ] Writing partition recovery with recovery.img [ 47073280 bytes ]
[ 439.8788 ] [.....] 100%
[ 441.9190 ] Writing partition recovery-dtb with tegra234-p3701-0004-p3737-0000.dtb.rec [ 378167 bytes ]
[ 441.9264 ] [.....] 100%
[ 441.9435 ] Writing partition esp with esp.img [ 67108864 bytes ]
[ 441.9484 ] [.....] 100%
[ 444.6100 ] Writing partition APP with system.img [ 59055800320 bytes ]
[ 444.6163 ] [.....] 003%
```

```
tar: Read checkpoint 460000
tar: Read checkpoint 470000
tar: Read checkpoint 480000
tar: Read checkpoint 490000
tar: Read checkpoint 500000
tar: Read checkpoint 510000
tar: Read checkpoint 520000
tar: Read checkpoint 530000
tar: Read checkpoint 540000
tar: Read checkpoint 550000
tar: Read checkpoint 560000
tar: Read checkpoint 570000
tar: Read checkpoint 580000
writing item=16, 9:0:secondary_gpt, 61203267072, 16896, gpt_secondary_9_0.bin, 16896, fixed-<reserved>-0, 8b
2a095a2f0562b9f5d2d878102e074cc7086de7
[ 305]: l4t_flash_from_kernel: Successfully flash the external device
[ 305]: l4t_flash_from_kernel: Flashing success
[ 305]: l4t_flash_from_kernel: The device size indicated in the partition layout xml is smaller than the actual size. This utility will try to fix the GPT.
Flash is successful
Reboot device
Cleaning up...
Log is saved to Linux_for_Tegra/initrdlog/flash_1-1_0_20240506-150619.log
ubuntu@ubuntu-DWL01:~/JCO-3000-ORN-A_JP512_V0.0.1$
```

4. The system will reboot after flashing all images.

4.2 MCU Control Functions

4.2.1 Control Functions

MCU driver can control or get status of the below functions.

- LED Control
- GPIO Control
- Device Mode Status
- Buzzer Control
- Com Port Control
- IGN Power On/Off Delay Time Control
- Setting Save Control
- GPIO Configuration Control

4.2.2 LED Control

Control L1 ~ L3 leds's behavior.

- ◆ The sysfs path : /sys/bus/i2c/devices/7-0040/
- ◆ Sysfs files : led_1 ~ led_3 (Read/Write)
- ◆ Control method :

```
$ echo value > /sys/bus/i2c/devices/7-0040/led_2
```

- ◆ Value format :

BIT number	Function	Default value
2 ~ 0	<Hz> 0: OFF, 7: ON, 1 ~6: Hz	0
5 ~ 3	<Light Count> 0: continuous, 1~ 7: count	0
6 ~ 7	<Gap Time> 0:continuous, 1 ~3 : 0.5~ 1.5S gap	0

4.2.3 GPIO Control

Read or setup GPIO status

- ◆ The sysfs path : `/sys/bus/i2c/devices/7-0040/`
- ◆ Sysfs files :
 - `gpio_in` (Read-only) : default value 0
 - `gpio_out` (Read/Write) : default value 0
- ◆ Control method :

```
$ cat /sys/bus/i2c/devices/7-0040/gpio_in
$ echo value > /sys/bus/i2c/devices/7-0040/gpio_out
```

- ◆ GPIO bit mapping :

- GPIO Input

Bit 7	Bit 6	Bit 5	Bit 4	Bit 3	Bit 2	Bit 1	Bit 0
'1'	'1'	'1'	'1'	IN4	IN3	IN2	IN1

`gpio_in` value calculation example:

$$(249)_{10} = (1111\ 1001)_2$$

- GPIO output

Bit 7	Bit 6	Bit 5	Bit 4	Bit 3	Bit 2	Bit 1	Bit 0
'0'	'0'	'0'	'0'	OUT4	OUT3	OUT2	OUT1

`gpio_out` value calculation example:

$$(1100)_2 = (12)_{10}$$

● Application circuit example:

■ DI application circuit:

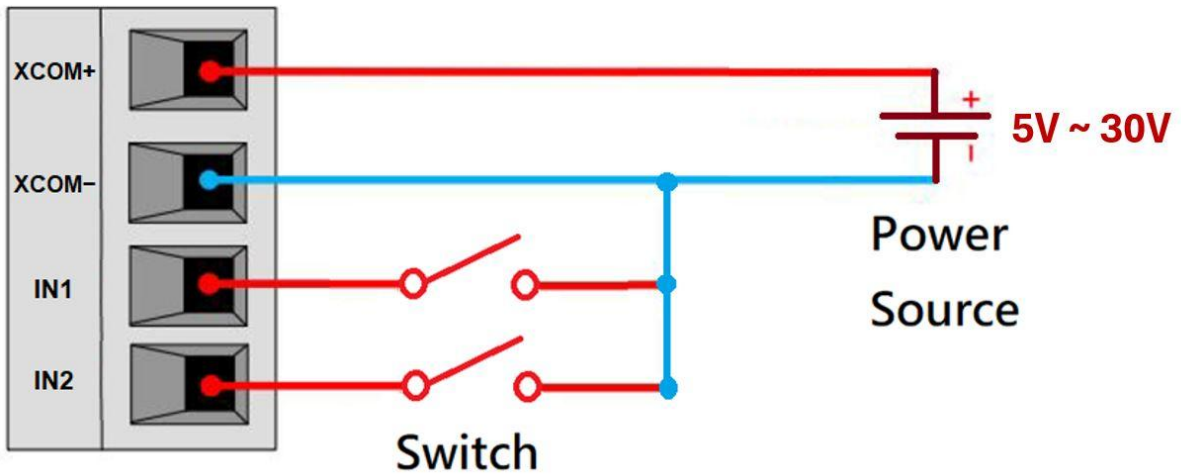

■ DO application circuit

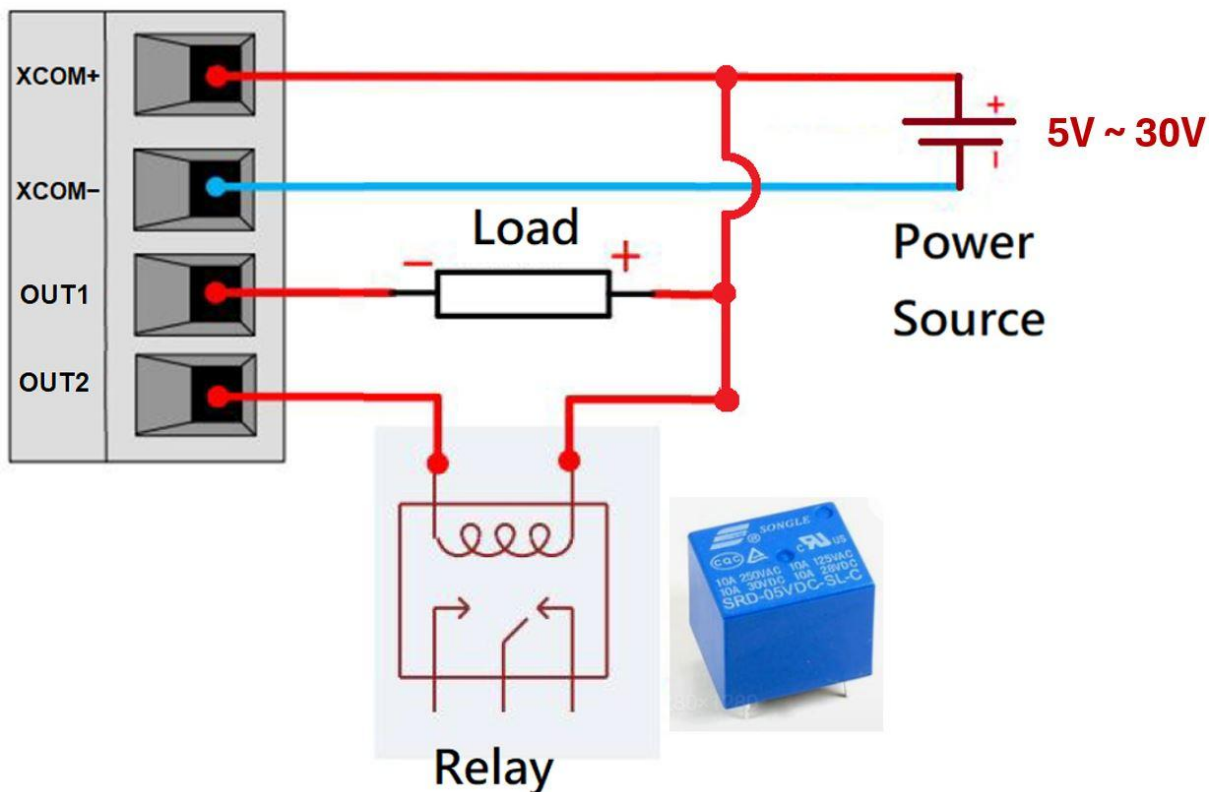

Note:

- Tx set value 0 to turn on the Relay or Load
- OUTx set value 1 to turn off the Relay or Load
- Control logic can be changed , refer to 4.2.10

4.2.4 Device Mode Status

Read device mode as PC MODE or IGN MODE

- The sysfs path : `/sys/bus/i2c/devices/7-0040/`
- Sysfs files : `device_mode` (Read-only)
- Control method :

```
$ cat /sys/bus/i2c/devices/7-0040/device_mode
```

- Value format :
 - PC MODE : PC mode
 - IGN MODE : Ignition Mode

4.2.5 Buzzer Control

Control buzzer function

- The sysfs path : `/sys/bus/i2c/devices/7-0040/`
- Sysfs files : `buzzer_time` (Read/Write) : default value 0
- Control method :

```
$ echo value > /sys/bus/i2c/devices/7-0040/buzzer_time
```

- Value format :

Buzzer turn on time : `value * 0.1 seconds` , then Buzzer turn off.

The value will auto clear to 0

4.2.6 Power on Buzzer Control

Enable or disable the buzzer when power on

- The sysfs path : `/sys/bus/i2c/devices/7-0040/`
- Sysfs files : `power_on_buzzer` (Read/Write) : default value 1 (EEPROM Save)
- Control method :

```
$ echo value > /sys/bus/i2c/devices/7-0040/power_on_buzzer
```

- Value format :

1 : Enable the Buzzer when power on.

0 : Disable the Buzzer when power on.

4.2.7 IGN Power On/Off Delay Time Control

Set IGN ON/OFF to SYS-PW ON/OFF delay time at ignition mode

- The sysfs path : `/sys/bus/i2c/devices/7-0040/`
- Sysfs files :
 - `ign_on_dly_s` (Read/Write) : default value 8 (EEPROM Save)
 - IGN ON to SYS-PW ON delay second
 - `sw_on_dly_s` (Read/Write) : default value 2 (EEPROM Save)
 - SYS-PW ON to BUTTON PUSH delay second
 - `sw_off_dly_s` (Read/Write) : default value 3 (EEPROM Save)
 - IGN OFF to BUTTON PUSH OFF MB delay second
 - `pw_off_dly_s` (Read/Write) : default value 60 (EEPROM Save)
 - BUTTON PUSH to SYS-PW OFF delay second
- Control method examples:

```
$ echo value > /sys/bus/i2c/devices/7-0040/ign_on_dly_s
$ cat /sys/bus/i2c/devices/7-0040/ign_on_dly_s
```

- Value format :

Value * 1 seconds

Range: 0 ~ 65535 seconds

- Set power button to trigger system shutdown immediately

```
$ gsettings set org.gnome.SessionManager logout-prompt false
```

4.2.8 Setting Save Control

Save the settings into the EEPROM

- The sysfs path : `/sys/bus/i2c/devices/7-0040/`
- Sysfs files : `rom_update` (Read/Write) : default value 0
- Control method :

```
$ echo 1 > /sys/bus/i2c/devices/7-0040/rom_update
```

- Value format :

Value > 0 , update (EEPROM SAVE) REG to EEPROM , update ok MCU auto clear to 0

4.2.9 GPIO Configuration Control

Set GPIO value reverse for every pin and default value of GPIO output pins when power on.

GPIO default setting :

- Input bit logic : following voltage level
 - ◆ Voltage Hi Level : '1'
 - ◆ Voltage Low Level : '0'
- Output bit logic :
 - ◆ Turn on device : '0'
 - ◆ Turn off device : '1'

When the GPIO reverse bit is set '1' , the GPIO logic shows as below:

- Input bit logic :
 - ◆ Voltage Hi Level : '0'
 - ◆ Voltage Low Level : '1'
- Output bit logic :
 - ◆ Turn on device : '1'
 - ◆ Turn off device : '0'
- The sysfs path : /sys/bus/i2c/devices/7-0040/
- Sysfs files :
 - ◆ gpio_in_reverse (Read/Write) : default value 0 (EEPROM Save)
 - ◆ gpio_out_reverse (Read/Write) : default value 0 (EEPROM Save)
 - ◆ gpio_out_power_on (Read/Write) : default value 0 (EEPROM Save)
- Control method :

```
$ cat /sys/bus/i2c/devices/7-0040/gpio_in_reverse
```

```
$ echo value > /sys/bus/i2c/devices/7-0040/ gpio_out_power_on
```

- GPIO bit mapping :
 - ◆ GPIO Input Inverse Bit

Bit 7	Bit 6	Bit 5	Bit 4	Bit 3	Bit 2	Bit 1	Bit 0
'0'	'0'	'0'	'0'	IN4	IN3	IN2	IN1

gpio_in_reverse value calculation example:

$$(9)_{10} = (0000\ 1001)_2$$

- GPIO output Inverse Bit

Bit 7	Bit 6	Bit 5	Bit 4	Bit 3	Bit 2	Bit 1	Bit 0
'0'	'0'	'0'	'0'	OUT4	OUT3	OUT2	OUT1

gpio_out_reverse value calculation example:

$$(0000\ 1100)_2 = (12)_{10}$$

- GPIO output Bit when power on

Bit 7	Bit 6	Bit 5	Bit 4	Bit 3	Bit 2	Bit 1	Bit 0
'0'	'0'	'0'	'0'	OUT4	OUT3	OUT2	OUT1

gpio_out_power_on value calculation example:

$$(0000\ 1100)_2 = (12)_{10}$$

Note: The value will be applied to “gpio_out” when power on

4.3 Create USERNAME and PASSWORD

Create username and password

User can create username and password of Ubuntu OS by command before flashing BSP image.

- Open terminal on Ubuntu host PC, then access the BSP image unzipped folder
- Enter the following command in terminal to change username and password in the image:

```
$ sudo Linux_for_Tegra/tools/l4t_create_default_user.sh -u  
username -p password -a -n pc_name --accept-license
```

Type what you want to replace the parameters:

- username
 - password
 - pc_name
-
- Follow section 4.1.2 to flash BSP image to system

4.4 GMSL Camera

JCO-1000-ORN-C supports GMSL cameras from OtoBrite and TechNexion.

◆ Switching Camera

Use `install_camera.sh` to switch the camera source

```
$ install_camera.sh
```

Select the camera you wish to use.

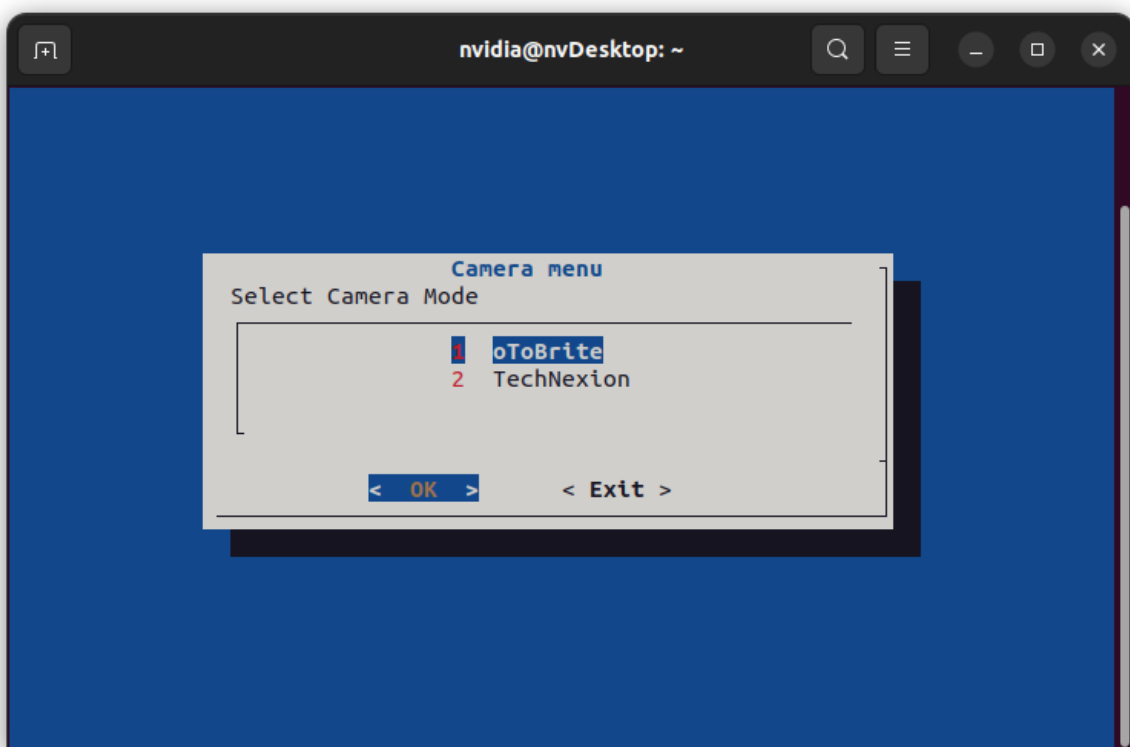

Reboot the system.

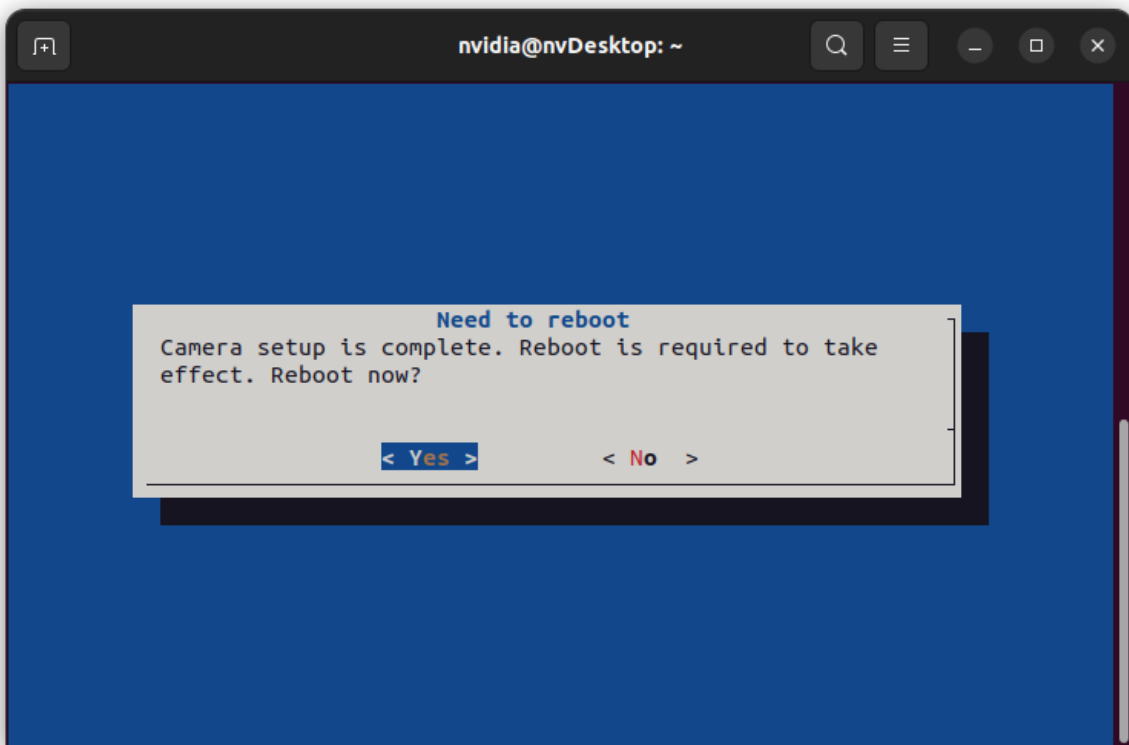

◆ Open Camera

Execute GmslCameraTest.sh to start the camera.

```
$ GmslCameraTest.sh
```

If using **TechNexion** hardware, you must select the appropriate camera mode to enable the stream.

